

— TVOŘÍME VAŠE POJÍZDNÉ DÍLNY —

# PROFESIONÁLNÍ díleňské vestavby



[www.do-dodavky.cz](http://www.do-dodavky.cz)

**Do-Dodávky**  
SYSTEM EDSTRÖM  
oficiální dealer pro Česko a Slovensko



**Do-Dodávky**

Více informací na našich webových stránkách [www.do-dodavky.cz](http://www.do-dodavky.cz)



## Simple

All our van racking systems are designed for ease-of-use and maximum efficiency.

## Crash-tested

We crash-test our systems to make sure your drivers – and their payloads – stay safe.

## Made in Sweden

We manufacture all our products in Sweden – a by-word for quality and durability.

## 5 Year Warranty

We offer a full parts and labour warranty on van racking fitted by our experienced installers for complete peace of mind.

## Better value for money

High-quality, long-lasting and lighter van racking to improve efficiency and reduce fuel costs.

## More than 60 years' experience

We have a proud history of developing the finest products and delivering the highest levels of customer service.

## Innovation

We are constantly investing in the future to develop lighter, more efficient systems – offering greater safety and cost-efficiency.

## Our commitment to quality

We are accredited to the highest international standards:

- ISO9001:2015 Quality Management System
- ISO14001:2015 Environmental Management System
- ISO45001 Occupational Health & Safety Management System
- VCA approved under the N1 Enhancement Scheme
- All auto-electrical installations certified to BS7671-Reg 18 standards
- Ford Quality Vehicle Management approved installer





2005 & 2007

### Základní rámy

Délka	Šířka	Výška	Kg	Part.No
300	31	505	1,6	2000
300	31	670	2,0	2002
300	31	890	2,5	2004
300	31	505/890	2,2	2005
300	31	1000	2,8	2006
300	31	670/1000	3,1	2007
300	31	1220	3,5	2008
300	31	1440	4,3	2010
470	31	505	1,9	2012
470	31	670	2,3	2014
470	31	825	2,6	2016
470	31	890	2,8	2018
470	31	1000	3,0	2020
470	31	1220	3,9	2022
470	31	1440	4,7	2024



### Rámy pro výsuvné police a police se sklopným čelem

Délka	Šířka	Výška	Kg	Part.No
300	31	360	1,4	2070
300	31	190	1,0	2071
470	31	360	1,8	2072
470	31	190	1,4	2073



### Přídavné rámy

Délka	Šířka	Výška	Horní délka	Kg	Part.No
300	31	185	160	1,0	2050
300	31	230	160	1,1	2052
300	31	290	160	1,2	2054
300	31	400	160	1,5	2056
470	31	185	300	1,3	2058
470	31	230	300	1,4	2060
470	31	290	300	1,6	2062
470	31	400	300	1,8	2064

Přídavné rámy jsou používány pro instalaci horních polic v místech, kde dochází k zaoblení karoserie vozu.



### Nastavitelná noha k ráům

Min.height	Max.height	Height	Kg	Part.No
10	400	500	0,6	2090

Nastavitelnou nohu k ráům používáme hlavně k instalaci rámu nad podběhy kol.

## Šuplíky



Čtyři různé šířky



Dvě délky &amp; tři různé výšky

## Šuplíky



Délka	Šířka	Výška	Kg	Part.No
300	302	110	3,4	2331
300	302	220	4,8	2332
300	392	110	3,8	2341
300	392	220	5,4	2342
300	392	165	4,6	2343
300	605	110	4,9	2361
300	605	220	7,2	2362
300	784	110	5,7	2371
300	784	220	7,2	2372
470	302	110	4,7	2431
470	302	220	6,5	2432
470	392	110	5,2	2441
470	392	220	7,2	2442
470	392	165	6,3	2443
470	605	110	6,4	2461
470	605	220	9,1	2462
470	784	110	7,8	2471
470	784	220	10,9	2472

Nosnost 60kg.



### Vrchní obložení



Délka	Šířka	Výška	Kg	Part.No
300	302	1	0,7	2533
300	392	1	0,9	2534
300	605	1	1,5	2536
470	302	1	1,1	2543
470	392	1	1,5	2544
470	605	1	2,3	2546

### Podpůrný rám

Délka	Šířka	Výška	Kg	Part.No
300	302	55	0,7	2633
300	392	55	0,8	2634
300	605	55	1,1	2636
470	302	55	0,9	2643
470	392	55	1,0	2644
470	392	120	2,0	2645
470	605	55	2,3	2646

### Šuplíkové organizéry



Délka	Šířka	Výška	Kg	Part.No
300	127	70	0,2	3001
300	172	70	0,3	3003
470	127	70	0,4	3005
470	172	70	0,4	3007

### Nápověda

Šířka šuplíku	Organizér	Šířka šuplíku	Oganizér
302 mm	127 mm, 2 ks	605 mm	127 mm, 3 ks + 172 mm 1 ks
392 mm	172 mm, 2 ks	784 mm	127 mm, 3 ks + 172 mm, 2 ks

### Pěnová výplň šuplíku

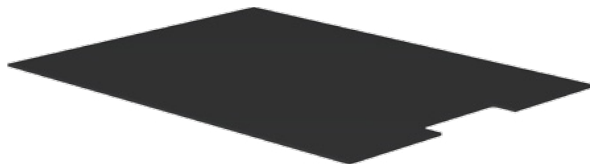

Vhodná pro	Tloušťka	Part.No
2331 & 2332	3	5233
2341, 2342 & 2343	3	5234
2361 & 2362	3	5236
2371 & 2372	3	5237
2431 & 2432	3	5243
2441, 2442 & 2443	3	5244
2461 & 2462	3	5246
2471 & 2472	3	5247

Zabraňuje hlučnosti.



### Vysouvací police

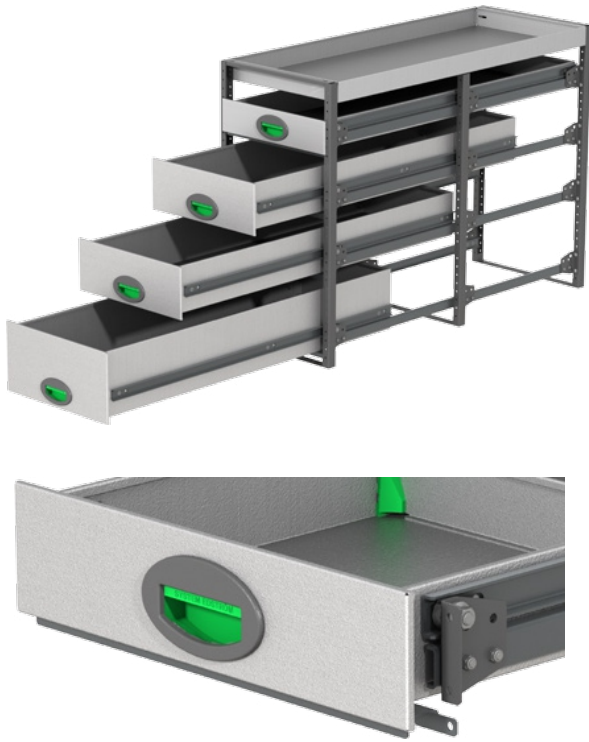

Délka	Šířka	Výška	Vhodné pro	Kg	Part.No
268	826	110	784 mm	7,4	1881
268	826	165	784 mm	8,0	1897
268	1035	110	997 mm	8,8	1882
268	1035	165	997 mm	9,6	1898
268	1218	110	1176 mm	10,1	1883
268	1218	165	1176 mm	10,9	1899
438	826	110	784 mm	8,9	1884
438	826	165	784 mm	9,9	1885
438	826	360	784 mm	12,7	1894
438	1035	110	997 mm	10,6	1886
438	1035	165	997 mm	11,7	1887
438	1035	220	997 mm	13,1	1888
438	1035	360	997 mm	15,1	1895
438	1218	110	1176 mm	11,9	1889
438	1218	165	1176 mm	13,3	1890
438	1218	220	1176 mm	14,8	1891
438	1218	360	1176 mm	17,2	1896

Nosnost polic 80 kg..

### Prepážky pro vysouvací police

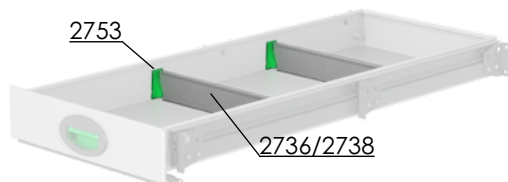

Depth	Height	Informace	Kg	Part.No
-	-	Držáky - pár	-	2753
436	62		0,4	2736
436	114		0,6	2738

2736 fits 1884 - 1891.

2738 is slightly higher and fits 1885, 1887, 1888, 1890 & 1891.



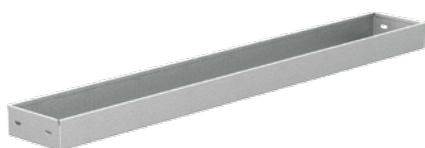
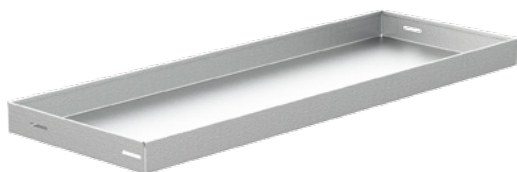

**Police**

Délka	Šířka	Gumová podložka	Kg	Part.No
300	302	6600	1,4	1600
300	392	6602	1,7	1602
300	605	6604	2,5	1604
300	694	6606	2,7	1606
300	784	6608	3,0	1608
300	907	6610	3,5	1610
300	997	6612	3,7	1612
300	1086	6614	4,0	1614
300	1176	6616	4,3	1616
300	1210	6618	4,4	1618
300	1299	6620	4,8	1620
300	1389	6622	5,0	1622
300	1512	6624	5,4	1624
300	1568	6626	5,6	1626
300	1960	6632	9,5	1632
400	605	6399 (rm)	2,9	1504
400	784	6399 (rm)	3,6	1508
400	997	6399 (rm)	4,4	1512
400	1176	6399 (rm)	5,1	1516
470	302	6700	2,0	1700
470	392	6702	2,4	1702
470	605	6704	3,4	1704
470	694	6706	3,8	1706
470	784	6708	4,2	1708
470	907	6710	4,8	1710
470	997	6712	5,2	1712
470	1086	6714	5,6	1714
470	1176	6716	6,1	1716
470	1210	6718	6,1	1718
470	1299	6720	6,5	1720
470	1389	6722	6,9	1722
470	1512	6724	7,5	1724
470	1568	6726	8,0	1726
470	1960	6799 (rm)	13,0	1730
160	997	6802	2,5	1802
160	1176	6804	2,9	1804
160	1568	6806	3,8	1806
160	1160-2120	6599 (rm)	5,5	1810
160	1830-3460	6599 (rm)	11,8	1812

Police s délkou 400mm mohou být také montovány do 300mm rámu.

Nosnost polic:  
 Police šířka 300 - 1600 mm 70 kg.  
 Polie šířka 1601 - 1960 mm 50 kg.  
 Nastavitelné police 30 kg.

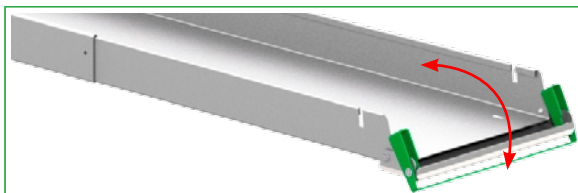

**Nastavitelné police se sklopným bočním čelem**

Délka	Šířka	Gumová podložka	Kg	Part.No
160	1830-3460	6599 (rm)	9,3	1813
300	1830-3460	6699 (rm)	13,5	1815

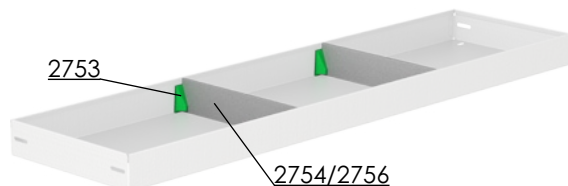

**Přepážky do polic**

Délka	Výška	Informace	Kg	Part.No
-	110	Držák jako pár	-	2753
300	110		0,2	2754
470	110		0,2	2756





### Police se sklopným čelem

Délka	Šířka	Gumová podložka	Kg	Part.No
300	605	6604	2,6	3604
300	784	6608	3,2	3608
300	907	6610	3,5	3610
300	997	6612	4,0	3612
300	1176	6616	4,5	3616
470	605	6704	3,7	3704
470	784	6708	4,5	3708
470	907	6710	5,0	3710
470	997	6712	5,5	3712
470	1176	6716	6,3	3716

Nosnost 70 kg.

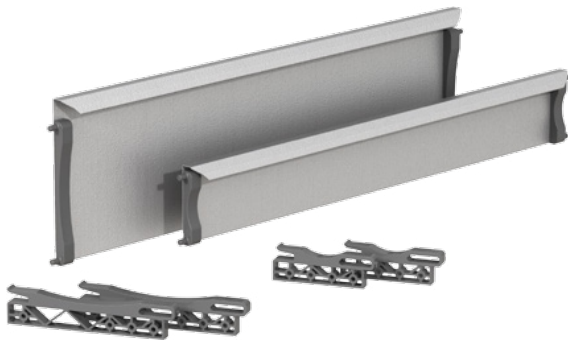

### Sklopné čela

Délka	Šířka	Výška	Kg	Part.No
38	605	110	0,9	3804
38	605	220	1,5	3805
38	784	110	1,2	3808
38	784	220	1,9	3809
38	907	110	1,3	3810
38	907	220	2,0	3811
38	997	110	1,4	3812
38	997	220	2,3	3813
38	1176	110	1,7	3816
38	1176	220	2,7	3817
38	1389	220	2,8	3823
38	1568	220	3,1	3827



### Přepážky pro police se sklopným čelem

Délka	Výška	Kg	Part.No
300	110	0,3	1990
300	220	0,5	1992
470	110	0,4	1994
470	220	0,8	1996



### Police pro kabelové cíčky

Depth	Width	Height	Kg	Part.No
300	784	114	3,0	1688
300	Extra divider	100	0,2	1689

Součástí police je jedna rozdělovací přepážka - možnost přibojednání.



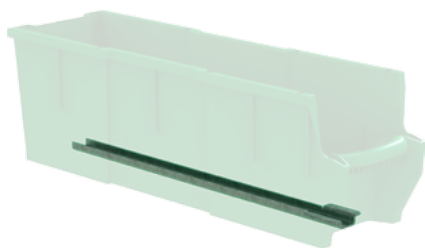
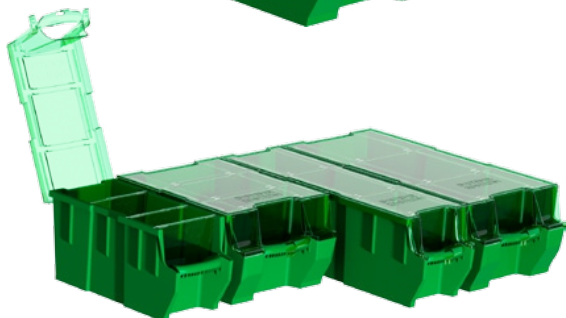

### Plastové multiboxy

Délka	Šířka	Výška	Kg	Part.No
300	145	154	0,4	3050
300	235	154	0,5	3052
470	145	154	0,5	3055
470	235	154	0,5	3057

### Víka pro multiboxy

Délka	Šířka	Pro	Kg	Part.No
300	150	3050	0,2	3060
300	240	3052	0,2	3062
470	150	3055	0,2	3065
470	240	3057	0,4	3067

### Rozdělovače pro multiboxy

Šířka	Výška	Pro	Part.No
150	154	3050, 55	3070
240	154	3052, 57	3072

### Držáky na multiboxy pro police se sklopným čelem

Délka	Kg	Part.No
300	0,1	3081
470	0,2	3082

### Nápověda

Šířka police	Police		Police se sklopným čelem		Police bez sklopného čela	
	150 mm	240 mm	150 mm	240 mm	150 mm	240 mm
302 mm	2					
392 mm	1	1				
605 mm	4		2	1	4	
694 mm	3	1				
784 mm	2	2		3	2	2
907 mm	6		4	1	6	
997 mm	5	1	6		5	1
1086 mm	4	2				
1176 mm	3	3	4	2	3	3
1210 mm		5				
1299 mm	7	1				
1389 mm	6	2				
1512 mm	10					
1568 mm	4	4				
1960 mm	5	5				

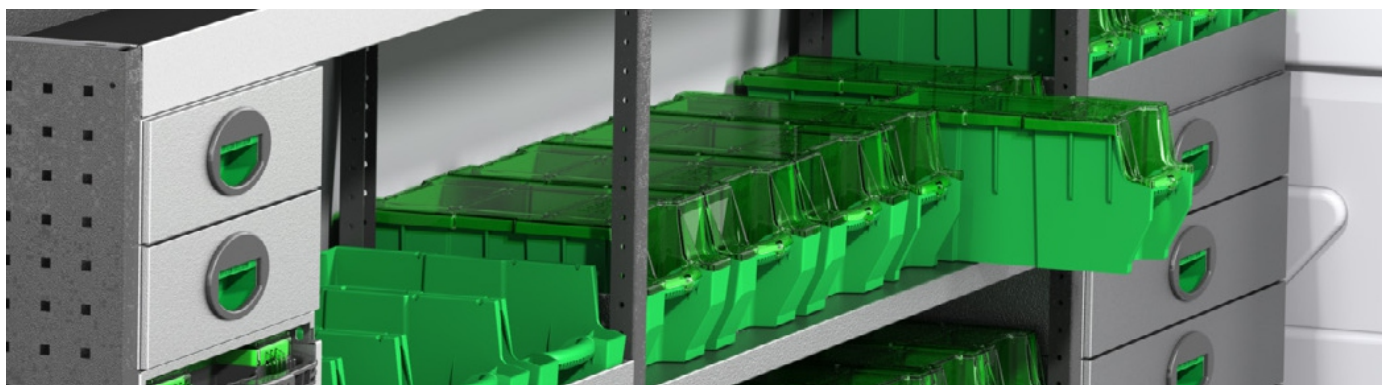

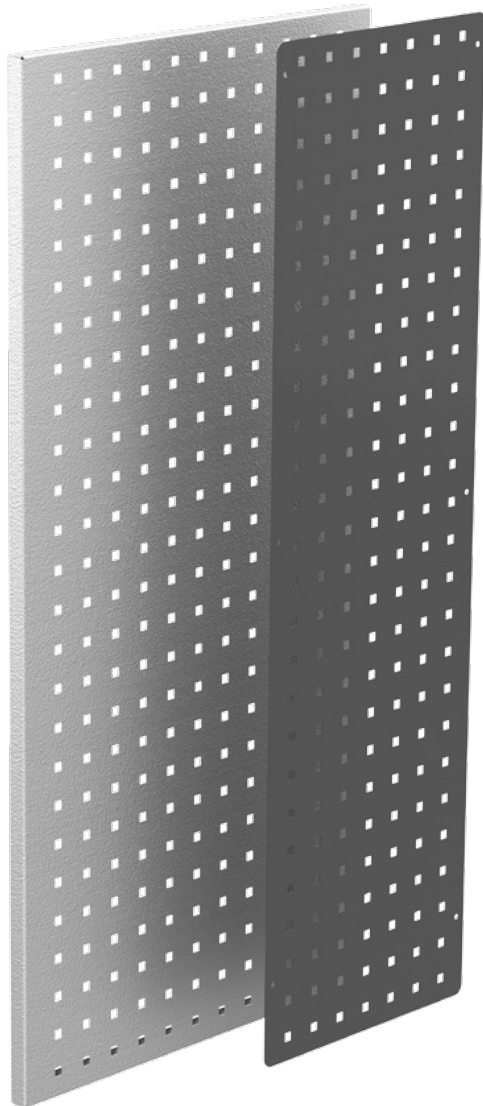

### Perforované obložení stěn regálů

Délka	Tloušťka	Výška	Kg	Part.No
300	0,7	505	0,8	2100
300	0,7	670	1,0	2102
300	0,7	890	1,4	2104
300	0,7	1000	1,5	2106
300	0,7	1220	1,9	2108
300	0,7	1440	2,2	2110
470	0,9	505	1,5	2120
470	0,9	670	2,0	2122
470	0,9	825	2,5	2123
470	0,9	890	2,7	2124
470	0,9	1000	3,0	2126
470	0,9	1220	3,7	2128
470	0,9	1440	4,4	2130

### Perforované tabule

Délka	Tloušťka	Výška	Kg	Part.No
300	20	890	2,4	2150
300	20	1000	2,7	2152
300	20	1220	3,3	2154
392	20	890	3,0	2155
470	20	890	3,6	2156
470	20	1000	4,0	2158
470	20	1220	4,8	2160
500	20	1500	6,1	2162
700	20	900	5,2	2164
700	20	1250	6,7	2166
700	20	1480	8,3	2168

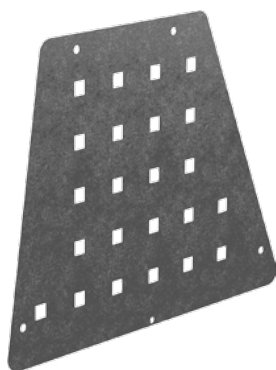

### Perforované stěny pro přídavné rámy

Délka	Tloušťka	Výška	Vhodné pro	Kg	Part.No
300	0,7	185	2050	0,3	2190
300	0,7	230	2052	0,3	2191
300	0,7	290	2054	0,3	2192
300	0,7	400	2056	0,5	2193
470	0,9	185	2058	0,5	2195
470	0,9	230	2060	0,6	2196
470	0,9	290	2062	0,7	2197
470	0,9	400	2064	1,0	2198

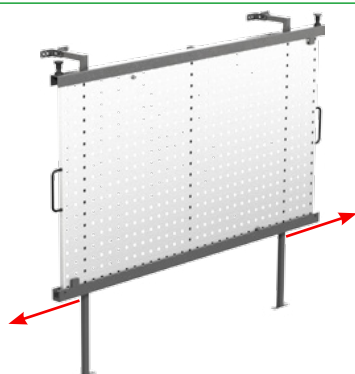

### Vysouvací perforované tabule

Délka	Šířka	Výška	Kg	Part.No
230	1250	700	23,5	T7800
230	1480	700	15,1	T7801
230	1220	470	11,6	T7803

Tabule je posuvná do obou směrů, nosnost 125 kg.

## Gumové podložky do polic



5204



Délka	Šířka	Kg	Part.No
1400	*	5,6	5204
160	*	0,2	6599
160	992	0,3	6802
160	1172	0,3	6804
160	1564	0,4	6806
298	298	0,1	6600
298	388	0,2	6602
298	600	0,3	6604
298	690	0,3	6606
298	780	0,4	6608
298	902	0,4	6610
298	992	0,4	6612
298	1082	0,4	6614
298	1172	0,5	6616
298	1204	0,5	6618
298	1295	0,6	6620
298	1384	0,6	6622
298	1506	0,6	6624
298	1564	0,6	6626
298	1956	0,8	6632
298	*	0,4	6699
400	*	0,6	6399
468	298	0,2	6700
468	388	0,3	6702
468	598	0,4	6704
468	690	0,5	6706
468	780	0,6	6708
468	902	0,7	6710
468	992	0,7	6712
468	1082	0,8	6714
468	1172	0,8	6716
468	1204	0,8	6718
468	1294	0,9	6720
468	1384	0,9	6722
468	1506	1,0	6724
468	1564	1,1	6726
468	*	0,8	6799

Gumové podložky mají tloušťku 1 mm.

## Gumové podložky pro vysouvací police



Fits in	Kg	Part.No
1881 & 1897	0,3	6808
1882 & 1898	0,4	6812
1883 & 1899	0,4	6816
1884, 1885 & 1894	0,4	6908
1886, 1887, 1888 & 1895	0,6	6912
1889, 1890, 1891 & 1896	0,7	6916



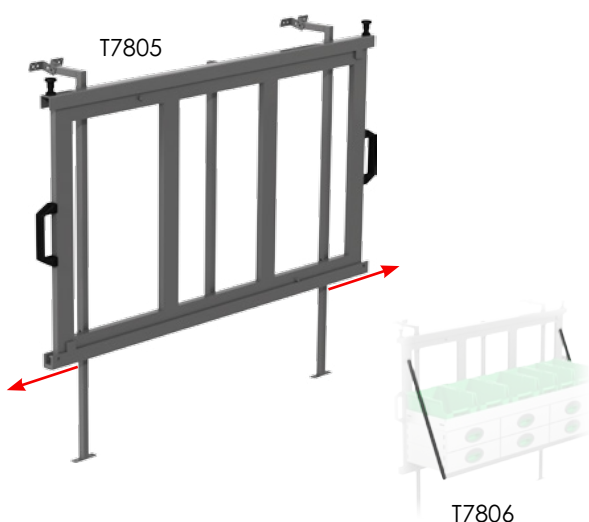

### Posuvný rám

Délka	Šířka	Výška	Kg	Part.No
230	1250	700	17,0	T7805

Výška rámu je nastavitelná pomocí nosných noh tak, aby se rám přizpůsobil rozměrům automobilu. Boční rám T7806 používáme ke stabilizaci připevněného příslušenství. Nosnost rámu je 140 kg.

Kg	Part.No
0,5	T7806

### Nakládací plošina

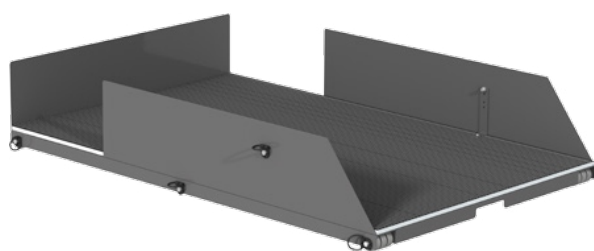

Délka	Výška	Kg	Part.No
1500	950	34,6	T7709
Univerzální přeprážka			10,5 T8393

Nosnost 190 kg.

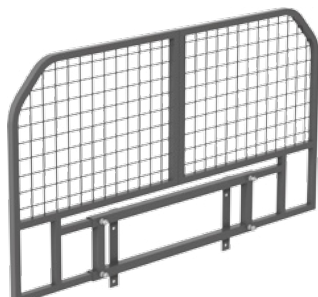



### Skříňky k podběhům kol

Délka	Šířka	Výška	Kg	Part.No
300	998	330	12,0	2760
300	1176	330	13,5	2762
300	1210	330	13,6	2764
470	998	330	14,1	2766
470	1176	330	15,4	2768
470	1210	330	15,6	2770



2782

2784

2780

### Skříně

Délka	Šířka	Výška	Kg	Part.No
470	392	770	19,5	2780
300	302	1155	12,8	2782
470	392	1155	18,7	2784

Levé nebo pravé otevírání - dle požadavků.



### Pořadač

Délka	Šířka	Výška	Kg	Part.No
373	197	385	6,7	2920



### Přihrádky

Délka	Šířka	Výška	Kg	Part.No
1500	250	300	23,0	5034
1700	250	300	25,0	5035

Robustní přihrádky na uložení páčidel, velkých ráčec apod....

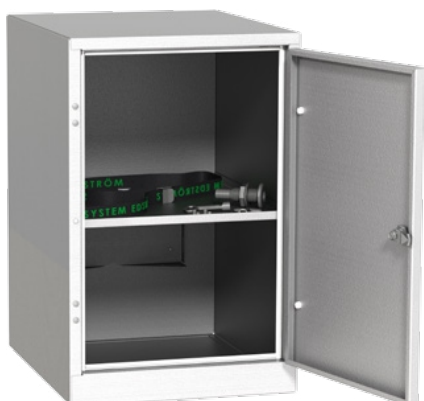

### Skříňka na malé tlakové láhve

Délka	Šířka	Výška	Kg	Part.No
470	392	605	18,5	2918

Součástí je popruh pro upevnění tlakových láhví.

### Nastavitelný rám

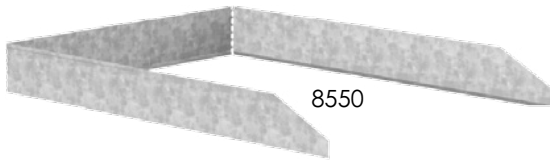

8550

Šířka		Délka		Výška	Kg	Part.No
Min	Max	Min	Max			
623	1234	950	1494	150	8,2	8550

Nastavitelný v délce a šířce tak, aby byl použitelný do všech dveří.

### Podlahy pro výsuvné rámy

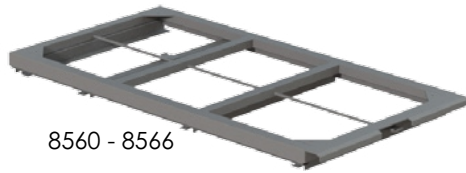

8560 - 8566

Délka	Šířka	Výška	Kg	Part.No
950	350	75	15,5	8560
1300	350	75	21,0	8561
1650	350	75	26,0	8562
950	700	75	20,9	8565
1300	700	75	28,0	8563
1650	700	75	35,0	8566

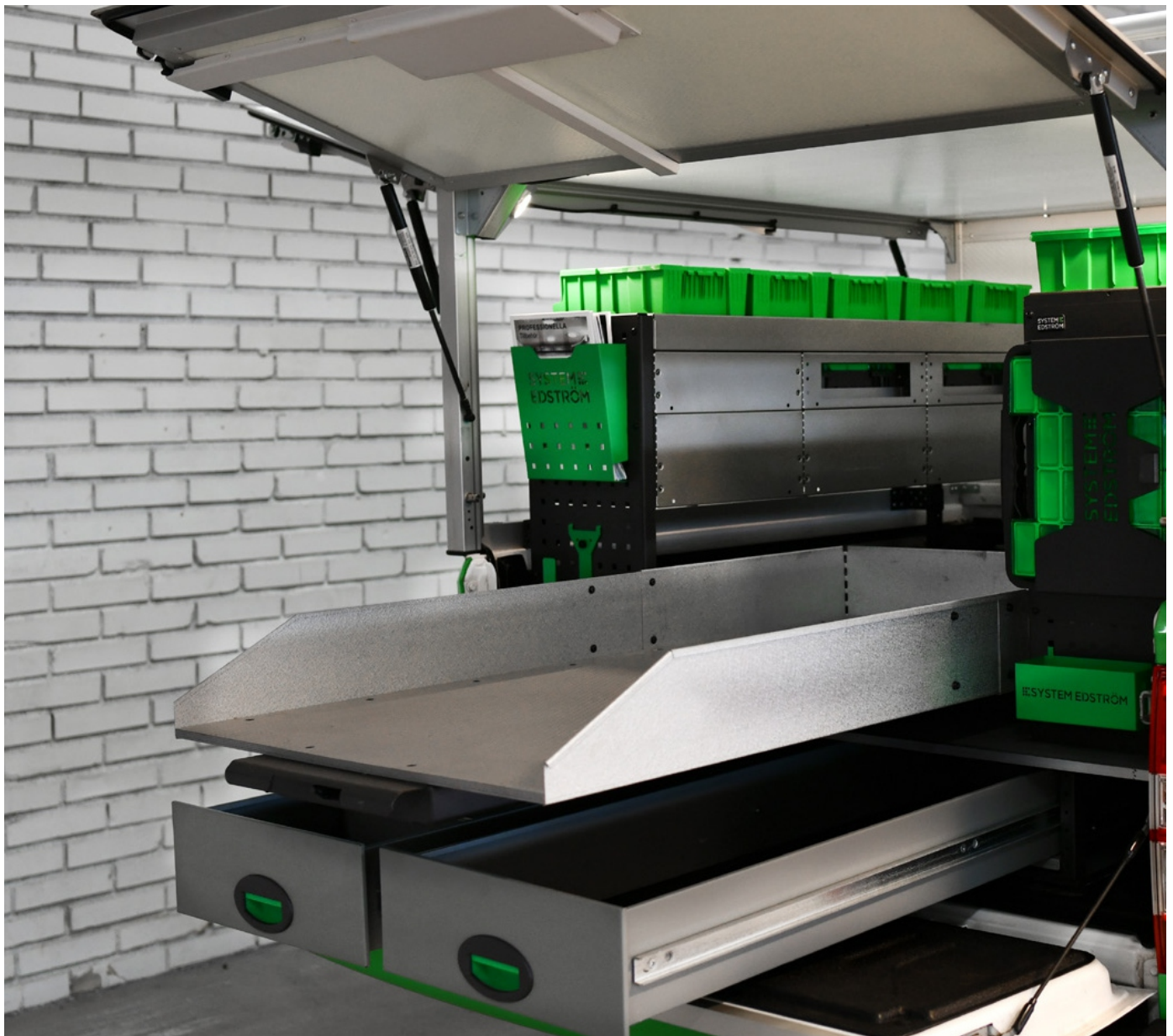



### Přenosný organizér

Délka	Šířka	Výška	Kg	Part.No
297	354	82	1,6	6302

Dodáváme s kombinovanými přihrádkami, které můžete přobjednat.

### Přihrádky pro organizér

Délka	Šířka	Výška	Part.No
40	77	68	6317
81	77	68	6318
163	77	68	6319

Vhodné také pro přihrádku 4360 a 4362, strana 22.

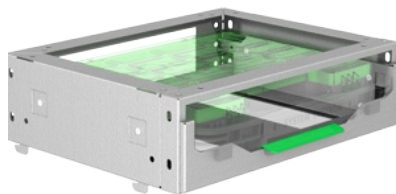

### Šuplík pro organizér

Délka	Šířka	Výška	Kg	Part.No
300	392	110	2,5	6300

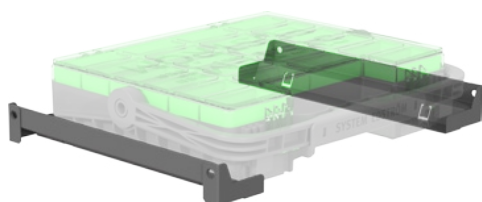

### Přihrádka pro organizér

Délka	Kg	Part.No
300	0,5	6305
470	0,7	6306

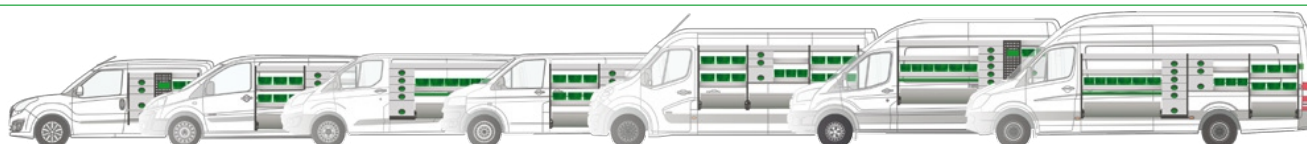

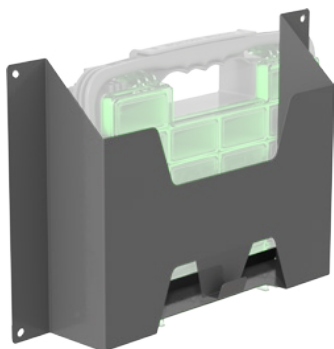

**Držák pro organizér**

Délka	Šířka	Výška	Kg	Part.No
86	565	295	1,4	6307

Držák k určený pro instalaci na hlavní rámy regálů.

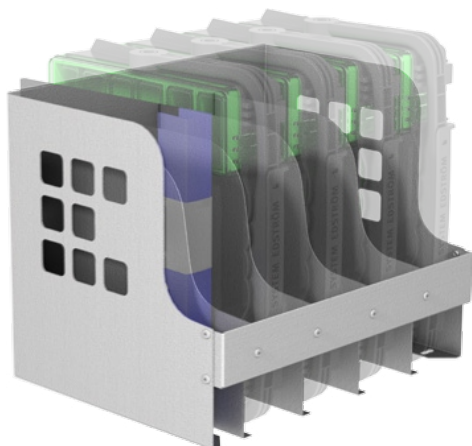
**Držák na organizéry / šanony**

Délka	Šířka	Výška	Kg	Part.No
304	383	299	4,4	6308

K uložení čtyř organizérů, určený pro instalaci na hlavní rámy regálů.

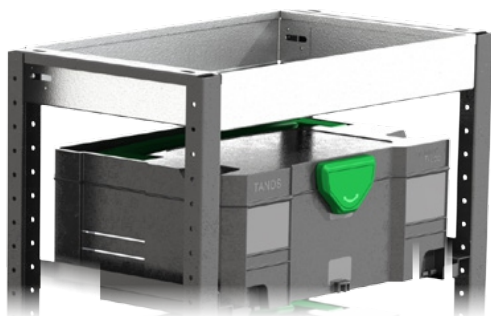
**Speciální police**

Délka	Šířka	Výška	Kg	Part.No
300	446	65	1,9	1686
300	-	-	0,4	2305

Určeno pro uložení populárních systainerů.  
Vhodné také pro kufříky 396 x 296 mm.  
Dodáváme bez systainerů.

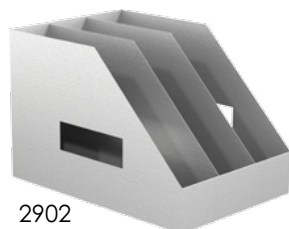
**Essve kufříkový system**

2902

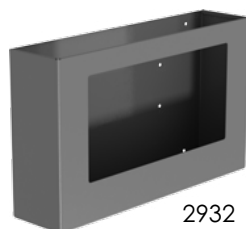

2932

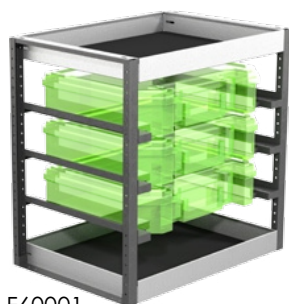

F60001



6754

Popis	Kg	Part.No
Shelf 470x605 mm	3,4	1704
Shelf frame 470x670 mm	2,3	2014
Case bracket 470 mm, depth	1,6	2310
EssBox case large	2,5	2312
EssBox case small	1,6	2313
Case stand for 3 cases	7,9	2902
Case bracket for Essbox large, 1 case	3,2	2932
Case bracket for Essbox small, 1 case	2,1	2933
Mounting kit for Essboxrack	0,2	5515
Plastic mat 462x595 mm	0,4	6754
Essboxrack for 3 cases	16,8	F60001

**Nastavitelný držák tlakových láhví**

Délka	Šířka	Výška	Průměr Ø	Kg	Part.No
150	300	97	< 300	0,9	2910

Pro upevnění láhve do průměru 320 mm.

**Držák tlakové láhve**

Délka	Šířka	Výška	Průměr Ø	Kg	Part.No
70	300	200	< 300	0,8	2912

**Držák na tlakové láhve double**

Délka	Šířka	Výška	Průměr Ø	Kg	Part.No
95	300	200	145	1,3	2913

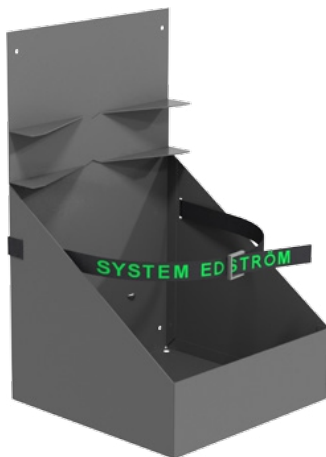
**Police pro tlakovou láhev**

Délka	Šířka	Výška	Kg	Part.No
300	306	500	6,3	2914

Vhodné pro 5 kg láhve, upínací popruh je součástí.

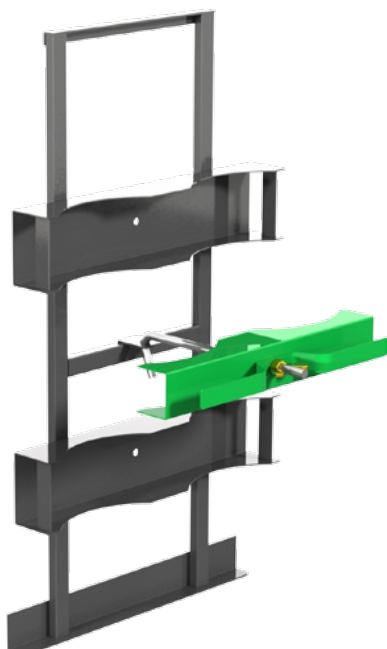
**Držák pro tlakové láhve**

Délka	Šířka	Výška	Průměr Ø	Kg	Part.No
300	450	820	205	5,8	2916

### Svěrák



Délka	Šířka	Výška	Kg	Part.No
360	135	140	10,3	5004

Otočný svěrák s maximálním otevřením 140 mm.

### Držáky na svěrák



Délka	Šířka	Výška	Kg	Part.No
1110	210	195	9,4	5012
1110	210	80	8,9	5013

Rozeř plochy 180x210 mm. Kryt 2950 je součástí (viz. níže).

### Vysouvací držáky pro svěrák a pracovní plochy



Šířka	Výška	Výsuvná plocha	Kg	Part.No
1200	151	997 mm	12,4	2720
1400	151	1176 mm	14,3	2721

### Sklopné držáky na svěrák a pracovní plochy

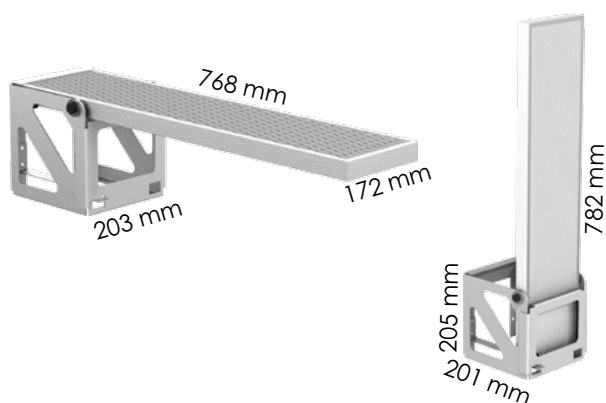

Kg	Part.No
6,0	2724

### Příslušenství pro držáky na svěrák

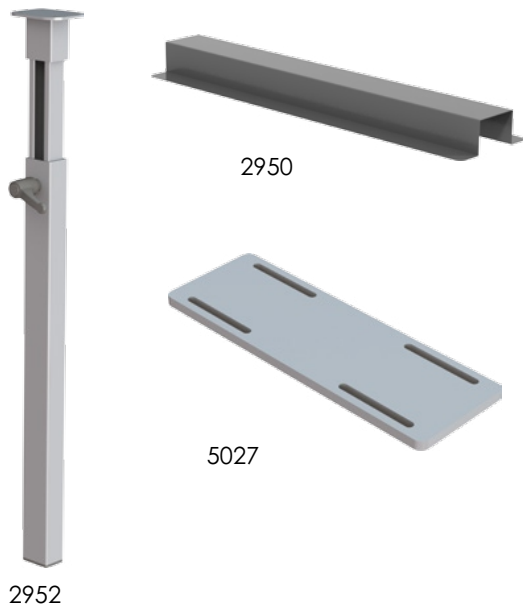

Description	Kg	Part.No
Kryt, součástí 5012 & 5013	1,1	2950
Nastavitelná noha, 520 - 800 mm	1,9	2952
Podložka pro 5012 & 5013 12 mm	0,4	5027

Nastavitelná noha je vhodná pro 2724, 5012 a 5013.  
Podložka je vhodná v případě manipulace přes práh.



### Case support

Depth	Length	Height	Kg	Part.No
220	1568	195	2,0	2935
-	-	-	0,6	2936

Adjustable bracket ideal for fixing between shelf frames to secure tool cases, for example. Comes in 1568 mm length, can be cut to fit your configuration. Add an extra bracket (2936) for maximum flexibility, one is included.

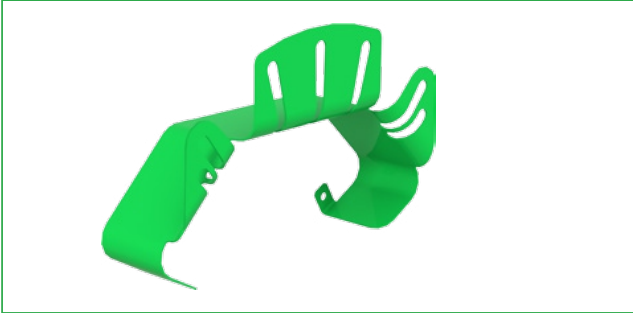

### Hose/Cable rack

Depth	Width	Height	Kg	Part.No
79	267	168	0,5	4077

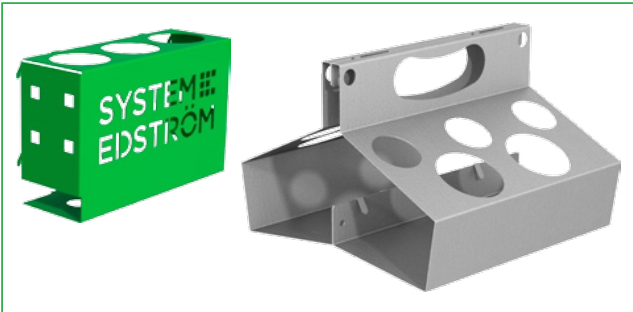

### Tube/Can holder

Depth	Width	Height	Kg	Part.No
66	194	123	0,4	4349
301	300	212	1,9	4350

4350 should be placed in a shelf or separate it in two halves and mount them on a pegboard.

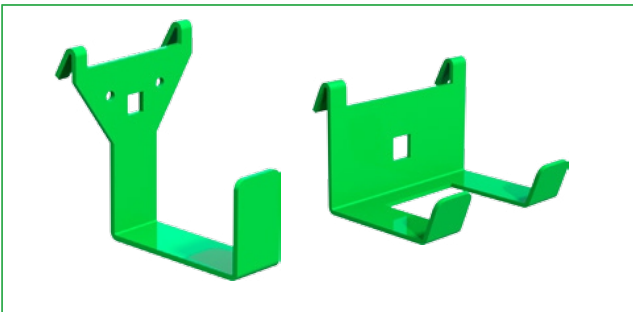

### Universal hook

Depth	Width	Height	Kg	Part.No
85	80	100	0,2	4356
61	83	55	0,1	4357

Simplicity at its best, heavy duty hooks, to be mount on a pegboard or hang it on the edge of a shelf. Secure the hook in a pegboard with a lock (page 30).

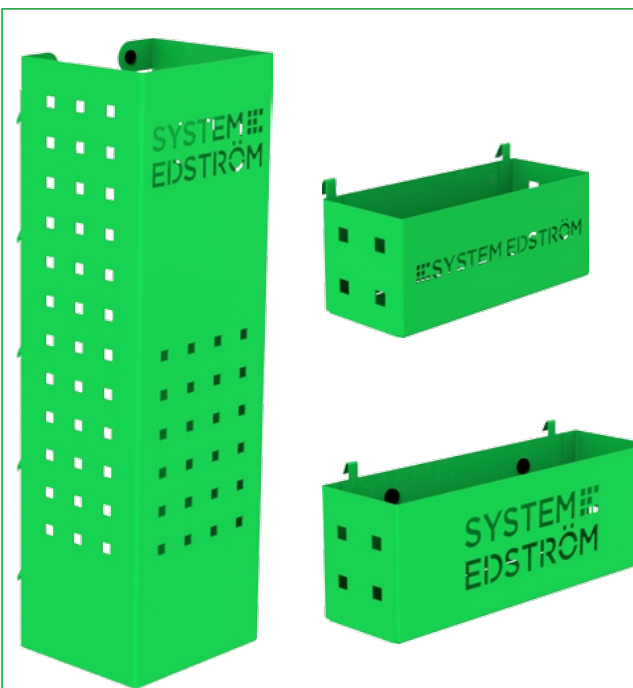

### Pegboard tray

Depth	Width	Height	Kg	Part.No
82	200	80	0,5	4360
82	285	102	0,8	4362
122	455	122	1,5	4364
153	179	575	3,0	4370

A number of different trays that solve (almost) all storage problems. Our tool case inserts, page 16, fits in 4360 and 4362, ideal for your small items that lack storage space.

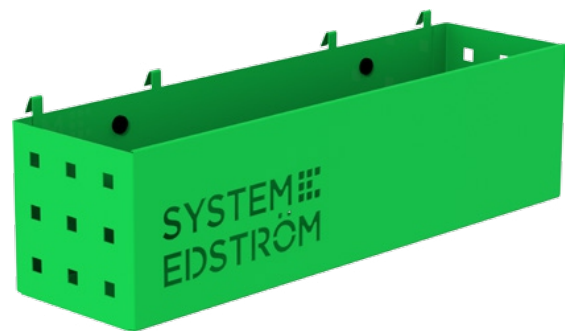

## File holders

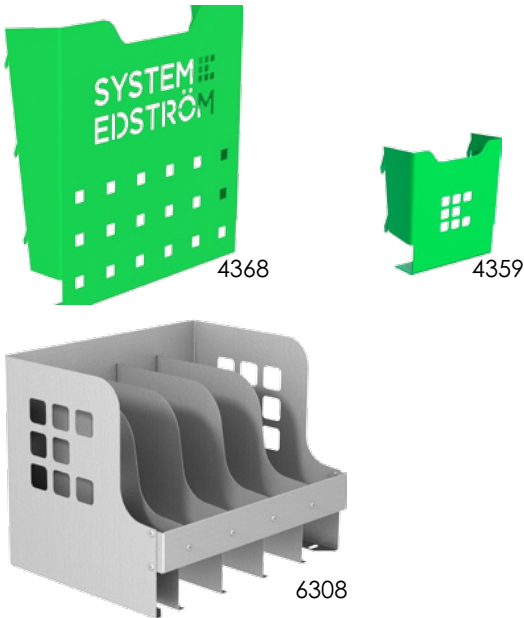

Depth	Width	Height	Kg	Part.No
21/31	65	79	0,1	4359
34/69	231	210	0,6	4368
304	383	299	4,4	6308

Not everything is digital, here you have storage for binders, brochures, etc. In 6308 you can store a mix of our tool case, page 16, and binders, should be placed on a shelf. 4359 is suitable for your business cards.

## Clothes hook

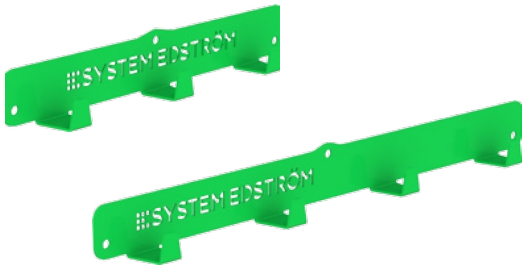

Depth	Width	Height	Kg	Part.No
31	295	40	0,3	2706
31	465	40	0,5	2708

We call it a clothes hook but, needless to say, you can use it to hang up whatever you want on it.

## Work bench



Depth	Width	Thickness	Kg	Part.No
500	900	30	9,2	6035
500	1300	30	13,4	6036
500	1700	30	16,5	6037
500	2100	30	20,5	6038
500	3000	30	30,5	6039



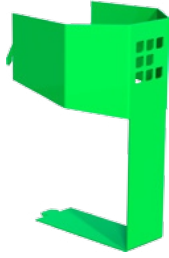

**Spray can holder**

Ø	Height	Part.No
80	113	4351

Sold separately.



**Can holder, plastic**

Ø	Height	Part.No
58-70	190	4358

Sold separately.



**Clamping rack**

Length	Height	Loops	Part.No
440	28	20	4354

Sold separately.



**Tool holder kit**

Parts	Part.No
25	4319

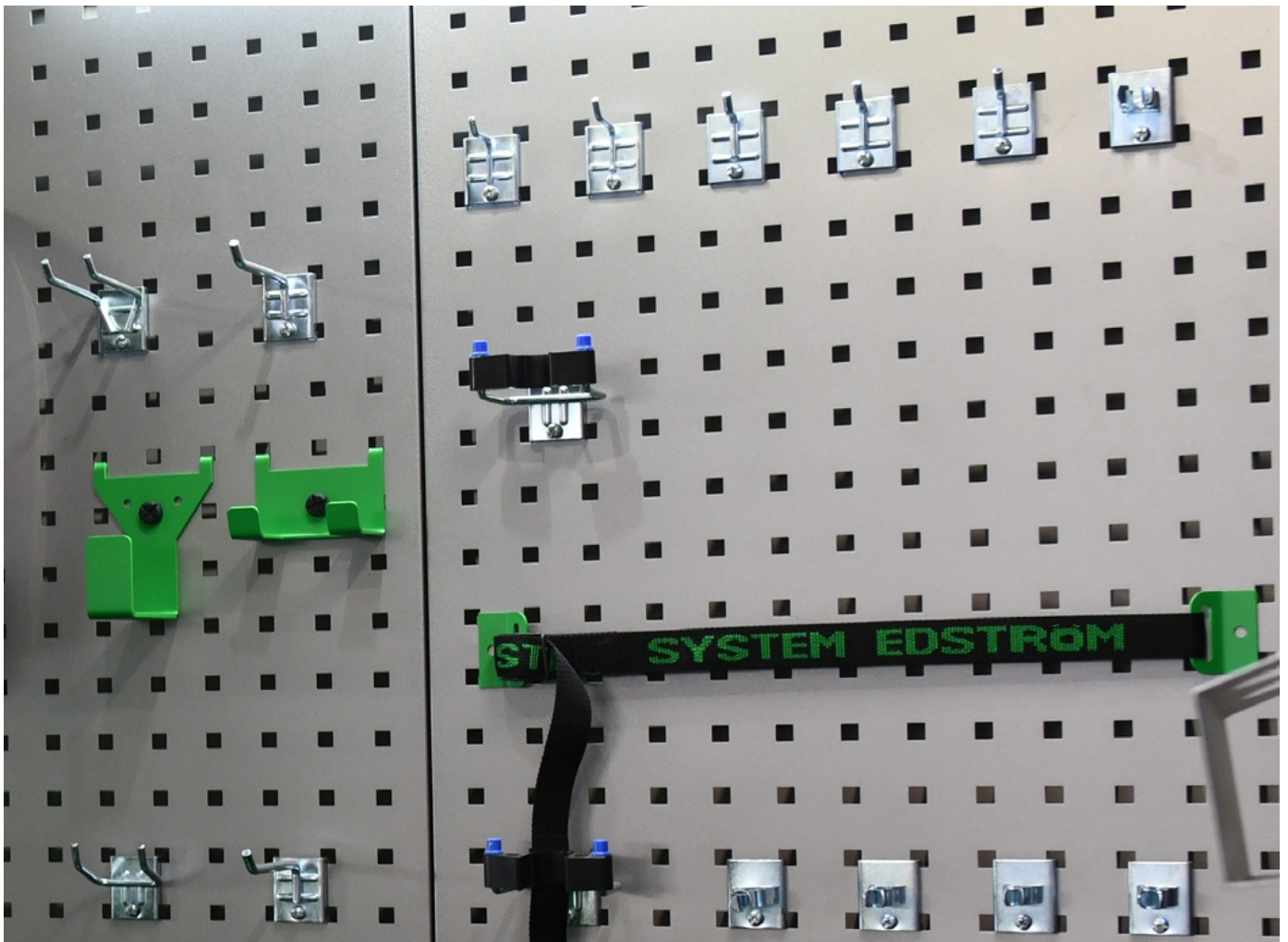

**Strap with brackets**



Information	Width	Part.No
1200 mm, nylon strap	25	4365
1000 mm, elastic strap	25	4366

The brackets will fit on our pegboards.



**Nylon strap**

Length	Width	Part.No
4000	30	5107

2-part with tensioner.

**Nylon strap**

Length	Width	Part.No
2520	25	5117

2-part with hooks.

**Nylon strap**

Length	Width	Part.No
2500	25	5118

**Fire extinguisher**

Information	Part.No
2 kg, powder	5055
4 kg, powder	5056
6 kg, powder	5057

Wall bracket is included.

**Rubber strap**

Length	Part.No
-	5121
285	5122
By the meter Whole package 10 meter.	5124
285	5125

**Lashing ring**

Part.No
5097

**Lashing ring**

Part.No
5098

**Lashing ring**

Part.No
5099

### Water can



#### Information

Bracket  
Water can with tap, 5 litres

#### Part.No

2970  
2972

The bracket can be mounted on a shelf frame or pegboard. Bracket and can sold separately.

### Grab handle



#### Art.Nr

4390

The handled is mounted on a shelf frame or directly in your vehicles chassis.

### Paper dispenser



#### Information

Magnetic bracket to 5084  
Dispenser with paper  
Paper to 5084

#### Part.No

5083  
5084  
5086

### First aid



#### Information

First aid board  
First aid kit

#### Part.No

5080  
5082

### Basket



Depth	Width	Height
235	305	350

#### Part.No

5079

### Edstrom colours



#### Information

Dark grey, spray can  
Light grey, spray can  
Edström green, spray can

#### Part.No

9007  
9014  
9015



### Flexiplan

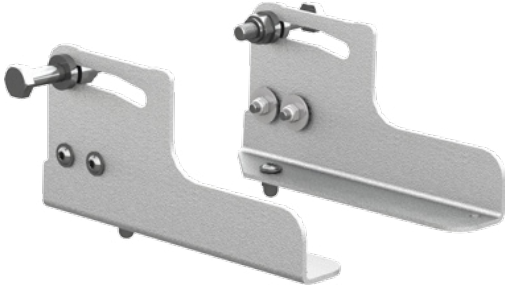

Width	Height	Kg	Part.No
2000	1800	14,1	1370
-	1800	4,5	1371
-	-	1,1	1372

#### Guide for flexiplan

Sections	Max Length	Articles
1	2000	1 x 1370
2	2000	1 x 1370 + 1 x 1371
3	3000	2 x 1370
4	4000	2 x 1370

Shelves and mounting kits (1372) must be added, one 1372 per shelf. See shelves on page 6, don't exceed 1568 mm length.

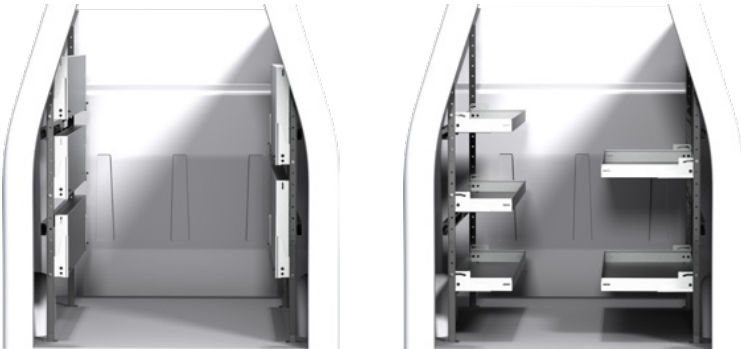

### Tube pipe tube



Length	Width	Height	Kg	Part.No
3050	125	125	14,0	8467

Our proven pipe carrier with a load retrieval device inside the tube which gives easy access to your pipes.

### Internal ladder holder



Length	Kg	Part.No
2400	5,2	T8900

Store your ladder on the inside of the roof, pull it back to the rear door in a simple operation. The aluminum rail comes in two parts with a joining piece.



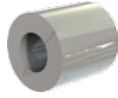

### Distance tube for pegboards

**Part.No**

3031

### Expander lock for pegboards

**Part.No**

5680

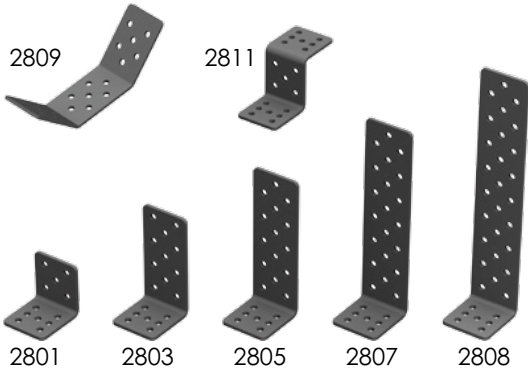

### Angle brackets

Width	Measurement	Part.No
53	58 x 58	2801
53	58 x 112	2803
53	58 x 154	2805
53	58 x 209	2807
53	58 x 264	2808
53	80:87:80	2809
53	58:64:58	2811



### Installation kits

Information	Parts	Part.No
Mixed parts, size 1	146	5501
Mixed parts, size 2	238	5502
For vice and vice holder	57	5510
False floor installation kit	93	T5310



**Brackets**

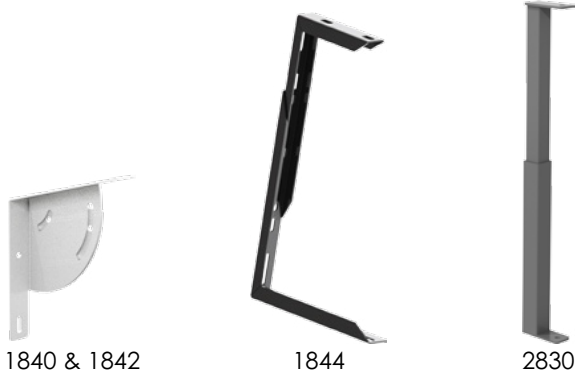

Depth	Height	Kg	Part.No
160		0,3	1840
300		0,5	1842
	260-410 mm	0,9	1844
	235-410 mm	0,6	2830

**Mounting brackets**

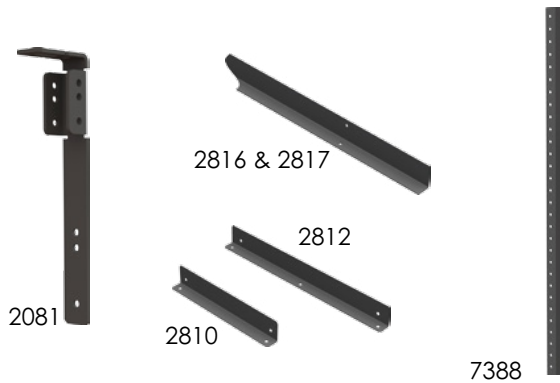

Length	Measurement	Kg	Part.No
200	26 x 54	0,3	2081
295	50 x 30	0,3	2810
460	50 x 30	0,5	2812
2000 (5 pcs)	50 x 30	12,3	2816
1568	50 x 30	2,0	2817
1200		0,9	7388

2081 is designed to use with our shelf frames, one example is to join two frames on top of each other.  
7388 is a pole with the same profile as our shelf frames.

**Shelf joint**

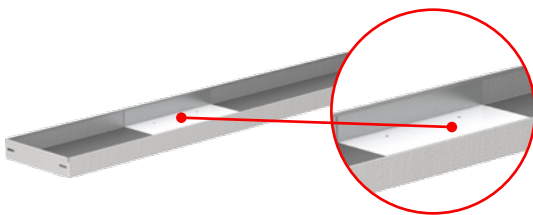

Depth	Kg	Part.No
300	1,3	1834

Should you require a shelf width not included within our standard range then you may utilise the shelf joint to shorten a shelf or connect two shelves to a desired width. (Only 300 mm deep shelves)

**Flipfront**

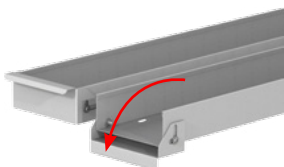

Depth	Kg	Part.No
160	0,3	1831
300	0,5	1833

**L-type support rail**

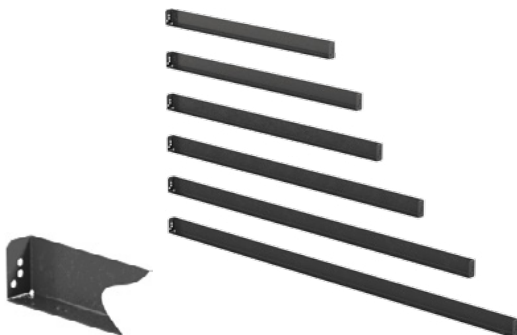

Length	Measurement	Kg	Part.No
784	50 x 30	1,1	2820
907	50 x 30	1,2	2822
997	50 x 30	1,4	2824
1176	50 x 30	1,6	2826
1389	50 x 30	1,6	2828
1568	50 x 30	1,7	2829

**Cross brace**



Kg	Part.No
0,8	2850

The brace is suitable for all sizes of sliding shelves and shelf frames above 505mm. It can also be used in conjunction with our standard shelves up to 1176mm in length.

# INFORMATION



## QUALITY

We are committed to offering the best possible service. Our quality management processes are certified to ISO 9001, so van users, fleet managers and leasing companies can trust us to deliver our products to standard and on time.

And all our materials are 100% recyclable – helping you meet your environmental commitments.



## DUTY OF CARE

Our systems are designed to keep your vehicles, tools and equipment as safe as possible.

But your fleet and your drivers also have a duty of care. Make sure that all tools, equipment and cargo are stored securely.

If installing our van racking systems yourself, be certain your installers have the knowledge and experience to fit them correctly.

Never exceed the maximum payload of the vehicle.



## SAFETY

All our products are crash-tested to the strictest requirements, ensuring that when the van stops, the cargo stops too.

We crash-test to two standards: at Millbrook in the UK (ECE 17:07) and at Valutec in France (INRS NS286).

Visit [www.systemedstrom.co.uk](http://www.systemedstrom.co.uk) for more information on our company, our products and our commitment to you.



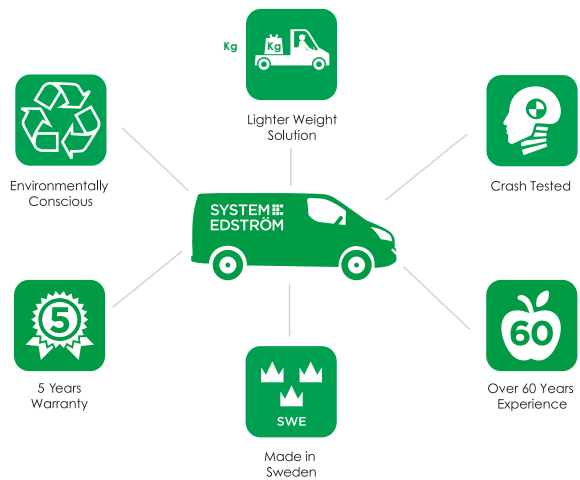
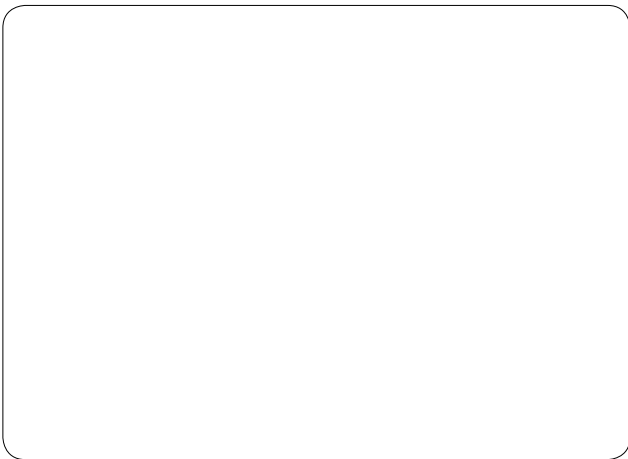
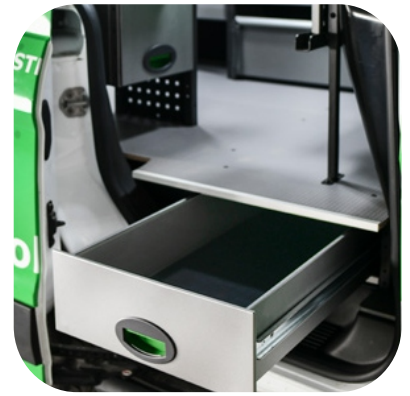

e.&o.e

# SYSTEM EDSTRÖM

**EDSTRÖM OF SWEDEN LTD.**  
7 Cronin Road  
Weldon South Industrial Estate  
Corby, Northamptonshire  
NN18 8AQ

**CONTACT**  
Telephone: 01536 20 30 40  
email: info@edstrom.co.uk  
Web: systemedstrom.co.uk

Doc1.1 v5\_08.19