

— CREATES MOBILE WORKPLACES —

PROFESSIONAL Van Racking



SYSTEM 
EDSTRÖM



SYSTEM
EDSTRÖM

SYSTEM
EDSTRÖM

CREATES MOBILE
WORKPLACES



Scan this code for
price information.

For more information: www.systemedstrom.com
We apply sales terms according to LCV14.



SIMPLICITY

CRASH TESTED

MADE IN SWEDEN

UP TO 5 YEARS WARRANTY

GREATER VALUE FOR MONEY

MORE THAN 60 YEARS OF EXPERIENCE

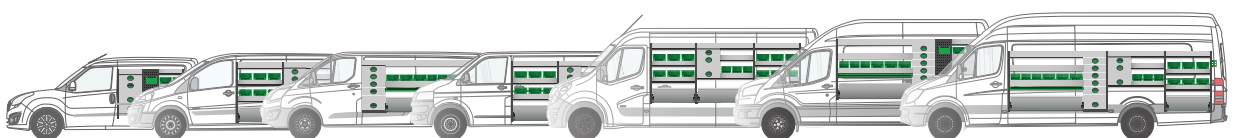



300 mm - 2005 & 2007
470 mm - 2019 & 2021

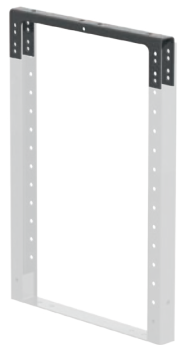
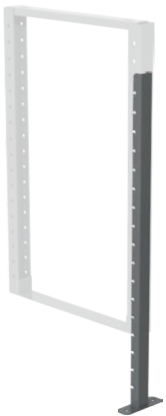

Shelf frames

Depth	Width	Height	Kg	Part.No
300	31	505	1,2	2000
300	31	670	1,5	2002
300	31	890	1,9	2004
300	31	505/890	1,7	2005
300	31	1000	2,1	2006
300	31	670/1000	1,9	2007
300	31	1220	2,6	2008
300	31	1440	3,2	2010
470	31	505	1,4	2012
470	31	670	1,7	2014
470	31	825	2,0	2016
470	31	890	2,1	2018
470	31	505/890	1,9	2019
470	31	1000	2,3	2020
470	31	670/1000	2,1	2021
470	31	1220	2,9	2022
470	31	1440	3,5	2024

Shelf frames for false floor and sliding drawers

Depth	Width	Height	Kg	Part.No
300	31	190	0,8	2071
300	31	250	0,9	2076
300	31	360	1,1	2070
470	31	190	1,1	2073
470	31	250	1,1	2075
470	31	360	1,3	2072
650	31	190	1,4	2079
650	31	250	1,6	2078
650	31	360	1,8	2077

Shelf frame support leg

Min.	Max.	Height	Kg	Part.No
10	400	500	0,4	2090

Shelf frame support legs can be installed to allow for fitting at uneven parts of the van; over the wheel arch for example.

Shelf frame top

Depth	Width	Height	Kg	Part.No
300	28	70	0,3	2084
470	28	70	0,4	2085

If you need a shelf frame height we don't have, cut a shelf frame to appropriate height and use the shelf frame top.
NOTE! Be sure to rust-protect the cuts.

Shelf frame extensions

Depth	Width	Height	Depth top	Kg	Part.No
300	31	185	160	0,7	2050
300	31	230	160	0,8	2052
300	31	290	160	0,9	2054
300	31	400	160	1,1	2056
470	31	185	300	1,0	2058
470	31	230	300	1,1	2060
470	31	290	300	1,2	2062
470	31	400	300	1,4	2064

Shelf frame extensions are used for fitting additional shelving to the top of a racking. Two different angles for different curvatures of the van.

Drawer system



Drawers



Depth	Width	Height	⇒	Kg	Part.No
300	302	110	105%	3,4	2331
300	302	220	105%	4,8	2332
300	392	110	105%	3,8	2341
300	392	220	105%	5,4	2342
300	392	165	105%	4,6	2343
300	605	110	105%	4,9	2361
300	605	220	105%	7,2	2362
300	784	110	105%	5,7	2371
300	784	220	105%	7,2	2372
470	302	110	105%	4,7	2431
470	302	220	105%	6,5	2432
470	392	110	105%	5,2	2441
470	392	220	105%	7,2	2442
470	392	165	105%	6,3	2443
470	605	110	105%	6,4	2461
470	605	220	105%	9,1	2462
470	784	110	105%	7,8	2471
470	784	220	105%	10,9	2472

Combine our drawers to a cabinet optimised to suit you and your business.

Payload 60 kg, uniformly distributed.





Top plates

Depth	Width	Height	Kg	Part.No
300	302	1	0,7	2533
300	392	1	0,9	2534
300	605	1	1,5	2536
470	302	1	1,1	2543
470	392	1	1,5	2544
470	605	1	2,3	2546

Support plinths

Depth	Width	Height	Kg	Part.No
300	302	55	0,7	2633
300	392	55	0,8	2634
300	605	55	1,1	2636
470	302	55	0,9	2643
470	392	55	1,0	2644
470	392	120	2,0	2645
470	605	55	1,1	2646

For 784 mm wide drawers use 2 pcs of 392 mm wide support plinths.



Drawer inserts

Depth	Width	Height	Kg	Part.No
300	127	70	0,2	3001
300	172	70	0,3	3003
470	127	70	0,4	3005
470	172	70	0,4	3007

Drawer inserts, complete with dividers.

Fitting guide

Drawer width	Inserts	Drawer width	Inserts
302 mm	127 mm, 2 pcs	605 mm	127 mm, 3 pcs + 172 mm 1 pcs
392 mm	172 mm, 2 pcs	784 mm	127 mm, 3 pcs + 172 mm, 2 pcs

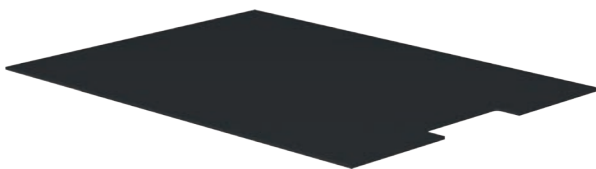

Drawer foam inserts

Fits in	Thickness	Part.No
2331 & 2332	3	5233
2341, 2342 & 2343	3	5234
2361 & 2362	3	5236
2371 & 2372	3	5237
2431 & 2432	3	5243
2441, 2442 & 2443	3	5244
2461 & 2462	3	5246
2471 & 2472	3	5247

Benefit from a quieter life by using lining foam in the drawers.





Extended sliding drawers

Depth	Width	Height	⇄	Kg	Part.No
268	826 (784)	165	90%	8,8	1921
268	826 (784)	220	90%	9,6	1922
268	826 (784)	360	90%	10,9	1923
268	1035 (997)	165	90%	10,6	1926
268	1035 (997)	220	90%	11,5	1927
268	1035 (997)	360	90%	12,9	1928
268	1218 (1176)	165	90%	12,3	1931
268	1218 (1176)	220	90%	13,3	1932
268	1218 (1176)	360	90%	14,8	1933
438	826 (784)	165	90%	10,4	1936
438	826 (784)	220	90%	11,3	1937
438	826 (784)	360	90%	13,0	1938
438	1035 (997)	165	90%	12,4	1941
438	1035 (997)	220	90%	13,4	1942
438	1035 (997)	360	90%	15,2	1943
438	1218 (1176)	165	90%	14,2	1946
438	1218 (1176)	220	90%	15,4	1947
438	1218 (1176)	360	90%	17,3	1948
616	826 (784)	165	90%	13,7	1900
616	826 (784)	220	90%	14,8	1901
616	826 (784)	360	90%	16,9	1902
616	1035 (997)	165	90%	15,8	1903
616	1035 (997)	220	90%	17,1	1904
616	1035 (997)	360	90%	19,3	1905
616	1218 (1176)	165	90%	18,5	1908
616	1218 (1176)	220	90%	19,8	1910
616	1218 (1176)	360	90%	22,2	1909



Payload 100 kg, uniformly distributed.

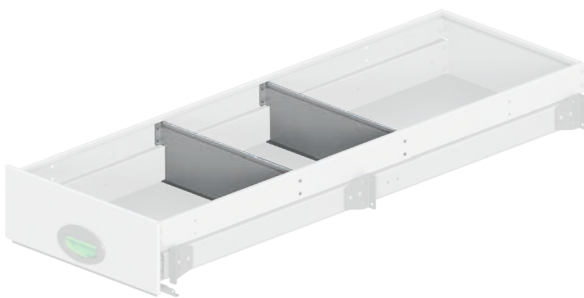

Dividers for sliding drawers

Depth	Height	Kg	Part.No
268	165	0,3	2748
268	220	0,4	2749
268	360	0,5	2750
438	165	0,5	2745
438	220	0,6	2746
438	360	0,9	2747
616	165	0,6	2742
616	220	0,9	2743
616	360	1,2	2744



Cover plate sliding drawers

Depth	Height	Kg	Part.No
300	30	0,2	2087
470	30	0,2	2088

Hide the gap that sometimes appear between the top drawer and shelf frame.

Shelves

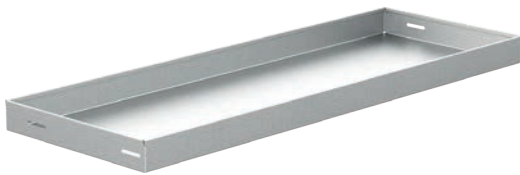

Depth	Width	Rubber mat	Kg	Part.No
300	302	6600	1,1	1600
300	392	6602	1,3	1602
300	605	6604	1,9	1604
300	694	6606	2,1	1606
300	784	6608	2,3	1608
300	907	6610	3,5	1610
300	997	6612	3,7	1612
300	1086	6614	4,0	1614
300	1176	6616	4,3	1616
300	1210	6618	4,4	1618
300	1299	6620	4,8	1620
300	1389	6622	5,0	1622
300	1512	6624	5,4	1624
300	1568	6626	5,6	1626
300	1960	6632	9,5	1632
400	605	6554	2,9	1504
400	784	6558	3,6	1508
400	907	6560	4,0	1510
400	997	6562	4,4	1512
400	1176	6566	5,1	1516
400	1389	6572	6,0	1522
400	1568	6576	6,8	1526
470	302	6700	1,5	1700
470	392	6702	1,8	1702
470	605	6704	3,4	1704
470	694	6706	3,8	1706
470	784	6708	4,2	1708
470	907	6710	4,8	1710
470	997	6712	5,2	1712
470	1086	6714	5,6	1714
470	1176	6716	6,1	1716
470	1210	6718	6,1	1718
470	1299	6720	6,5	1720
470	1389	6722	6,9	1722
470	1512	6724	7,5	1724
470	1568	6726	8,0	1726
470	1960	6730	13,0	1730
160	784	6800	1,5	1800
160	997	6802	1,9	1802
160	1176	6804	2,2	1804
160	1389	6805	2,6	1805
160	1568	6806	2,9	1806
160	1160-2120	6803	4,3	1810

Height 65 mm. 400 mm deep shelves should be mounted in 300 mm deep shelf frames.

Payload, uniformly distributed load:
Shelf width 300 - 1600 mm 70 kg.
Shelf width 1601 - 1960 mm 50 kg.
Adjustable shelves 30 kg.

Shelf dividers

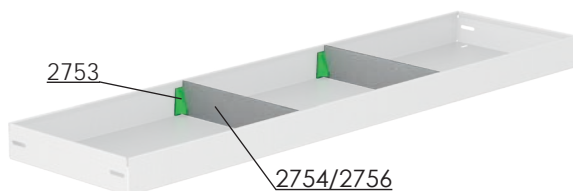

Depth	Height	Information	Kg	Part.No
-	110	Brackets, per pair	-	2753
300	110		0,2	2754
470	110		0,2	2756

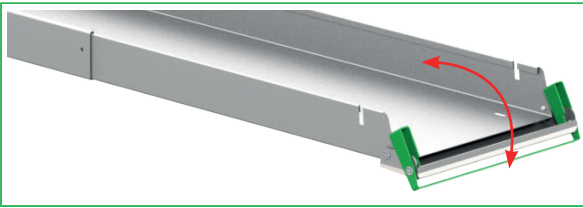

Adjustable shelves with flipfront

Depth	Width	Rubber mat	Kg	Part.No
160	1830-3460	6807	9,3	1813
300	1830-3460	6640	13,5	1815



Ball bearing kit for shelves

Depth	Height	⇔	Kg	Part.No
313	74	105%	2,5	2860
483	74	105%	3,8	2862

Mount a shelf in a ball bearing kit to make it extendable. This allows you to have more shelves, with easy access, in your van racking.



Payload 40 kg uniformly distributed load.

Application guide

Racking width	Shelf width in ball bearing kit
392 mm	302 mm
694 mm	605 mm
784 mm	694 mm
997 mm	907 mm
1086 mm	997 mm
1176 mm	1086 mm
1299 mm	1210 mm
1389 mm	1299 mm



Shelf for cable reels

Depth	Width	Height	Kg	Part.No
300	784	114	3,0	1688
300	Extra divider	100	0,2	1689

One movable divider is included. Payload 30 kg uniformly distributed load.



Dropfront shelves

Depth	Width	Rubber mat	Kg	Part.No
300	605	6604	2,6	3604
300	784	6608	3,2	3608
300	907	6610	3,5	3610
300	997	6612	4,0	3612
300	1176	6616	4,5	3616
470	605	6704	3,7	3704
470	784	6708	4,5	3708
470	907	6710	5,0	3710
470	997	6712	5,5	3712
470	1176	6716	6,3	3716

Height 90 + 27 mm.

Payload 70 kg uniformly distributed load.

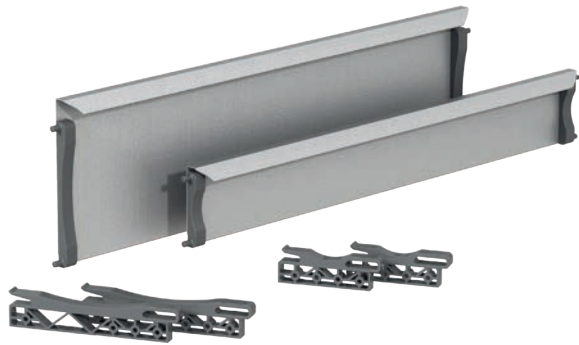

Drop fronts

Depth	Width	Height	Kg	Part.No
38	605	110	0,9	3804
38	605	220	1,5	3805
38	784	110	1,2	3808
38	784	220	1,9	3809
38	907	110	1,3	3810
38	907	220	2,0	3811
38	997	110	1,4	3812
38	997	220	2,3	3813
38	1176	110	1,7	3816
38	1176	220	2,7	3817
38	1210	220	2,5	3819
38	1389	220	2,8	3823
38	1568	220	3,1	3827

Supplied with fixing brackets.



Dividers for dropfront Shelves

Depth	Height	Kg	Part.No
300	110	0,3	1990
300	220	0,5	1992
470	110	0,4	1994
470	220	0,8	1996

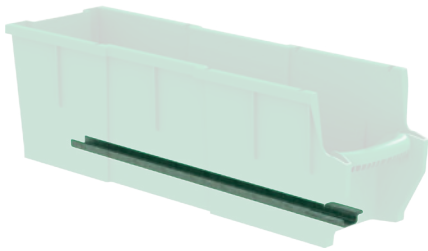

Plastic bin for shelves

Depth	Width	Height	Kg	Part.No
300	145	154	0,4	3050
300	235	154	0,5	3052
470	145	154	0,5	3055
470	235	154	0,5	3057

Transparent lid for plastic bins

Depth	Width	Fits	Kg	Part.No
300	150	3050	0,2	3060
300	240	3052	0,2	3062
470	150	3055	0,2	3065
470	240	3057	0,4	3067

Dividers for plastic bins

Width	Height	Fits	Part.No
140	154	3050, 55	3070
230	154	3052, 57	3072

Bracket for dropfront shelves

Depth	Kg	Part.No
300	0,1	3081
470	0,2	3082

No need for a front to your dropfront shelf when your bins snap into this bracket.

Fitting guide

Shelf width	Shelves		Dropfront shelves with front		Dropfront shelves without front	
	145 mm	235 mm	145 mm	235 mm	145 mm	235 mm
302 mm	2					
392 mm	1	1				
605 mm	4		2	1	4	
694 mm	3	1				
784 mm	2	2		3	2	2
907 mm	6		4	1	6	
997 mm	5	1	6		5	1
1086 mm	4	2				
1176 mm	3	3	4	2	3	3
1210 mm		5				
1299 mm	7	1				
1389 mm	6	2				
1512 mm	10					
1568 mm	4	4				
1960 mm	5	5				



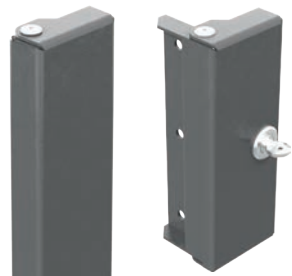

Locking bars

Description	Height	Kg	Part.No
Locking bar for drawers	160	0,6	4392
Locking bar for sliding shelves	440	1,1	4393

Complicate it for the thief, the locking bars mounts on a shelf frame.

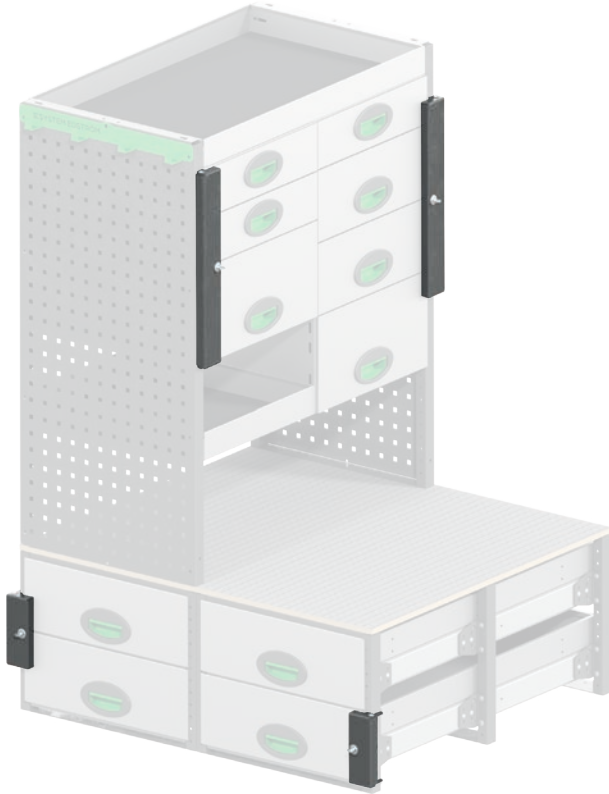

Rubber mats to sliding drawers

Measurement	Fits	Kg	Part.No
268 x 826	1921, 1922 & 1923	0,0	6930
268 x 1035	1926, 1927 & 1928	0,0	6932
268 x 1218	1931, 1932 & 1933	0,0	6934
438 x 826	1936, 1937 & 1938	0,0	6940
438 x 1035	1941, 1942 & 1943	0,0	6942
438 x 1218	1946, 1947 & 1948	0,0	6944
616 x 826	1900, 1901 & 1902	0,0	6918
616 x 1035	1903, 1904 & 1905	0,0	6919
616 x 1218	1908, 1909 & 1910	0,0	6920



Gummimattor



Depth	Width	Kg	Part.No
1400	*	5,6	5204
156	*	0,2	6599
156	780	0,2	6800
156	992	0,3	6802
156	1172	0,3	6804
156	1382	0,4	6805
156	1564	0,4	6806
156	2116	0,5	6803
156	3456	0,9	6807
298	298	0,1	6600
298	386	0,2	6602
298	598	0,3	6604
298	690	0,3	6606
298	778	0,4	6608
298	900	0,4	6610
298	990	0,4	6612
298	1080	0,4	6614
298	1170	0,5	6616
298	1202	0,5	6618
298	1292	0,6	6620
298	1382	0,6	6622
298	1504	0,6	6624
298	1562	0,6	6626
298	1953	0,8	6632
298	3456	1,5	6640
298	*	0,4	6699
404	600	0,3	6554
404	780	0,4	6558
404	900	0,5	6560
404	992	0,5	6562
404	1170	0,6	6566
404	1382	0,7	6572
404	1562	0,8	6576
404	*	0,5	6399
468	298	0,2	6700
468	386	0,3	6702
468	598	0,4	6704
468	688	0,5	6706
468	778	0,6	6708
468	900	0,7	6710
468	990	0,7	6712
468	1080	0,8	6714
468	1170	0,8	6716
468	1202	0,8	6718
468	1292	0,9	6720
468	1382	0,9	6722
468	1504	1,0	6724
468	1562	1,1	6726
468	1953	1,6	6730
468	*	0,8	6799

* = Säljes per löpmeter, hel rulle är 10 meter.
 Artikel nummer 5204 är en räfflad gummimatta tänkt att ha på golvet.

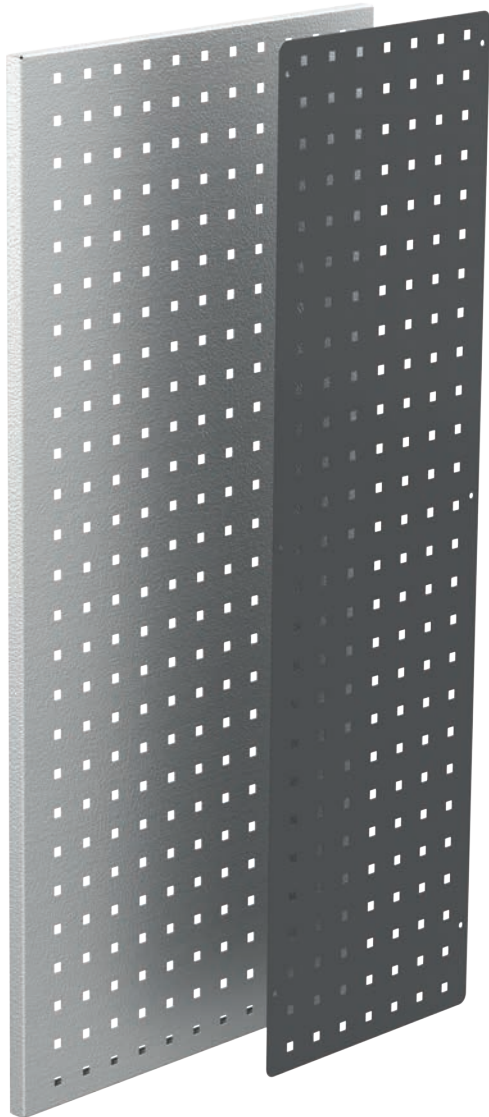

Pegboards plain sheet

Depth	Thickness	Height	Kg	Part.No
300	0,7	505	0,8	2100
300	0,7	670	1,0	2102
300	0,7	890	1,4	2104
300	0,7	1000	1,5	2106
300	0,7	1220	1,9	2108
300	0,7	1440	2,2	2110
470	0,9	505	1,5	2120
470	0,9	670	2,0	2122
470	0,9	825	2,5	2123
470	0,9	890	2,7	2124
470	0,9	1000	3,0	2126
470	0,9	1220	3,7	2128
470	0,9	1440	4,4	2130

All of our pegboards are made with square holes, 10x10 mm and 37 mm ^{c/}c

Pegboards flanged edge

Depth	Thickness	Height	Kg	Part.No
150	20	1000	1,6	2178
300	20	670	2,1	2148
300	20	890	2,4	2150
300	20	1000	2,7	2152
300	20	1220	3,3	2154
392	20	890	3,0	2155
470	20	890	3,6	2156
470	20	1000	4,0	2158
470	20	1220	4,8	2160
500	20	1500	6,1	2162
700	20	900	5,2	2164
700	20	1250	6,7	2166
700	20	1480	8,3	2168
846	20	890	6,1	2163



Pegboards for shelf frame extensions

Depth	Thickness	Height	Fits	Kg	Part.No
300	0,7	185	2050	0,3	2190
300	0,7	230	2052	0,3	2191
300	0,7	290	2054	0,3	2192
300	0,7	400	2056	0,5	2193
470	0,9	185	2058	0,5	2195
470	0,9	230	2060	0,6	2196
470	0,9	290	2062	0,7	2197
470	0,9	400	2064	1,0	2198

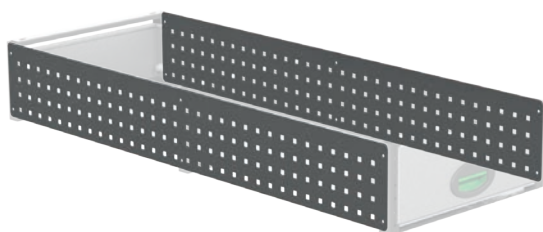

Pegboard to sliding shelves

Width	Thickness	Height	Kg	Part.No
826	0,9	360	1,9	2185
1035	0,9	360	2,4	2186
1218	0,9	360	2,8	2187

Pegboards are perforated in the middle. For 190 mm shelves, cut the pegboard to use both sides.

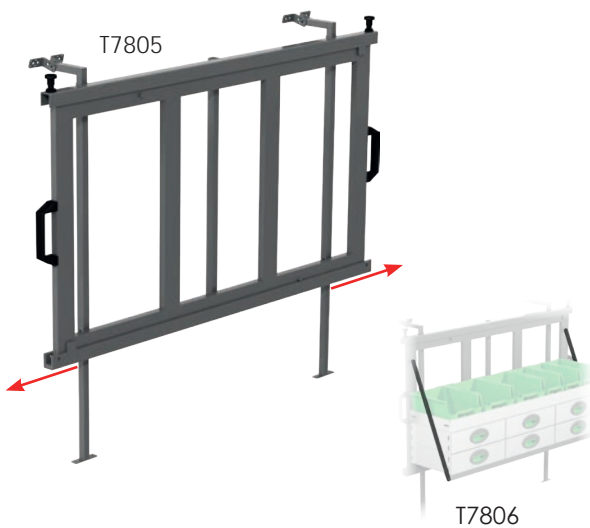

Sliding drawer & shelf frame

Depth	Width	Height	↔	Kg	Part.No
230	1250	700	65%	17,0	T7805

Total height is adjusted with the legs and the top brackets to fit your needs and space. Bracket T7806 is used to stabilise fitted interior, see picture above. The frame is extendable 2 ways. Payload 140 kg.

Kg	Part.No
0,5	T7806

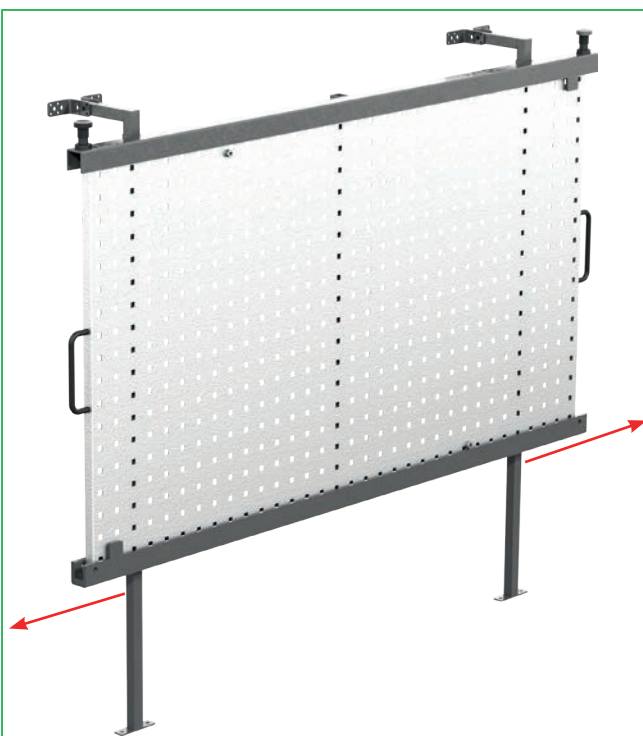

Sliding pegboard

Depth	Width	Height	↔	Kg	Part.No
230	1250	700	65%	23,5	T7800
230	1480	700	65%	15,1	T7801
230	1220	470	65%	11,6	T7803

The sliding pegboard is extendable in both directions. Payload 125 kg. Total height is set with the legs and upper brackets to suit the vehicle and your needs.

Sliding platform chassis

300-Chassis

Width	Length	⇒	Height	Kg	Part.No
350	950	87%	75	20,9	8570
350	1300	90%	75	28,1	8571
350	1450	91%	75	30,9	8572
350	1650	92%	75	34,5	8573
700	950	87%	75	26,2	8574
700	1300	90%	75	34,8	8575
700	1450	91%	75	37,5	8576
700	1650	92%	75	41,2	8577
1000	1450	91%	75	43,3	8580

300-chassis are extendable to 90 percent of their length.
 Payload is 300 Kgs evenly distributed.
 NOTE! The platforms is a chassis only – you design your own application.

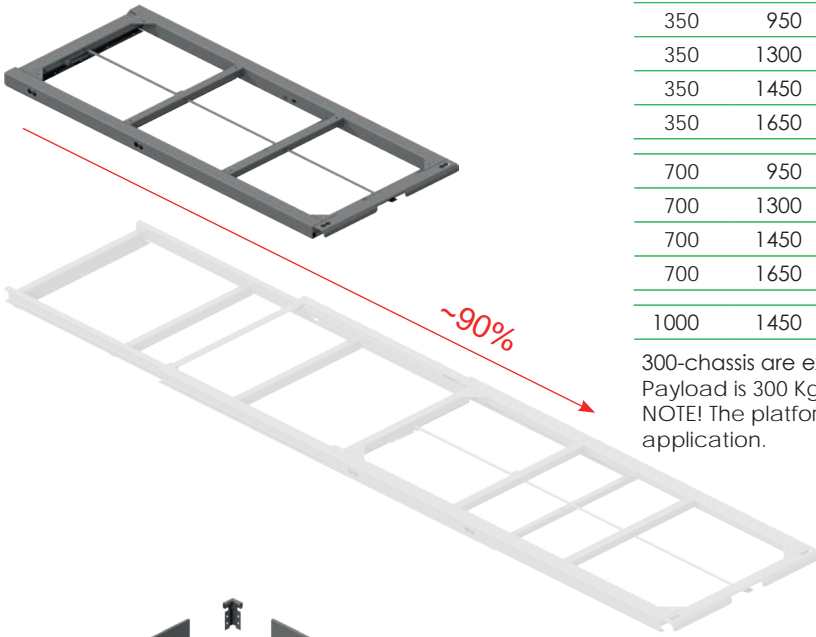

Frame

Width	Height	Kg	Part.No
1680	110	6,3	8551

A set contains of 3 rails and 2 corner brackets. You cut the rail to appropriate lengths.

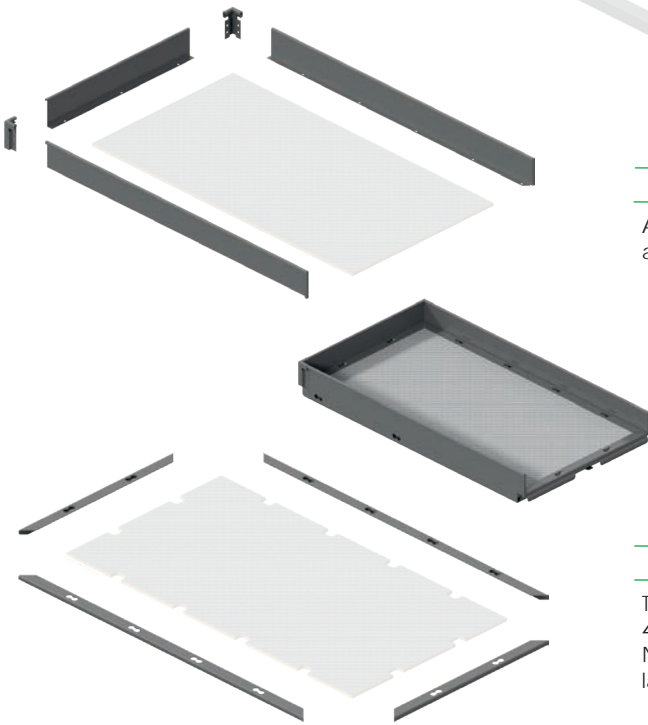

Lashing ring rail

Length	Width	Height	Kg	Part.No
1680	42	18	9,4	5906

The rail is designed for use with Airline lashing rings. Comes in a set of 4 rails that you cut to appropriate lengths.
 NOTE! You need to make holes in the plate so you get space for the lashing rings.

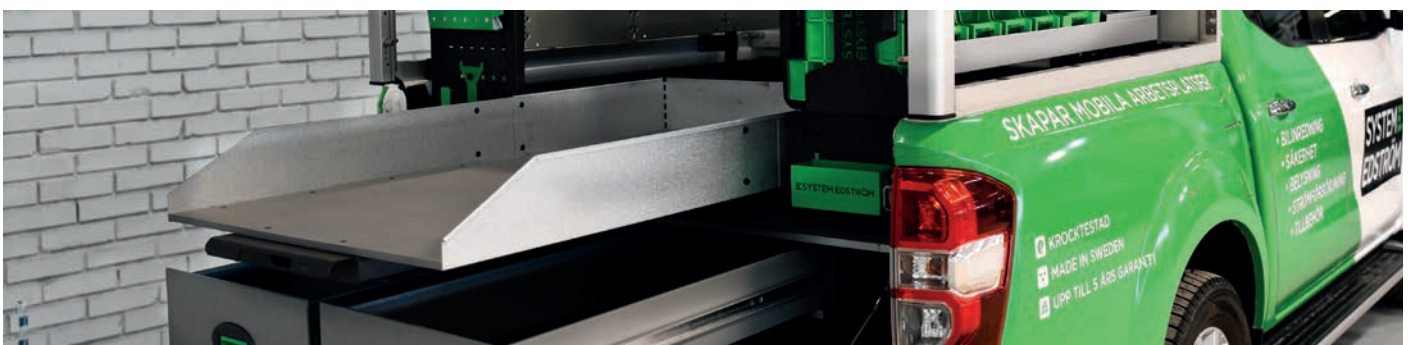

Load carrier



Depth	Width	Kg	Part.No
1500	950	34,6	T7709
Universal bulkhead		-	T8393

An alternative for passenger cars, fastened with nylon straps. Payload 190 kg, uniformly distributed load.

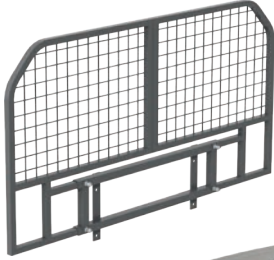

Tool compartments

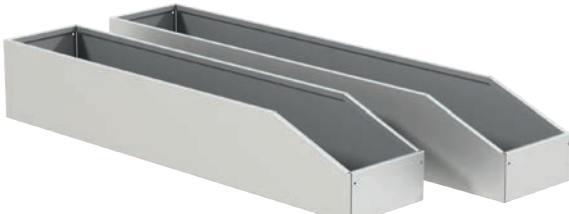

Depth	Width	Height	Kg	Part.No
1500	250	300	16,6	5034
1700	250	300	18,4	5035

Sturdy storage of shovels, crowbars and more.

Cabinets



2782

2784

2780

Depth	Width	Height	Kg	Part.No
470	392	770	19,5	2780
300	302	1155	12,8	2782
470	392	1155	18,7	2784

Left or right hinged door, as required.

2782 comes with two hooks, 2784 comes with two hooks and a rod.

File box



Depth	Width	Height	Kg	Part.No
373	197	385	6,7	2920

Gas bottle cabinet



Depth	Width	Height	Kg	Part.No
470	392	605	18,5	2918

Our gas bottle cabinet with sealed door, includes brackets for either 1 or 2 bottles, a removable shelf and vent pipe. The door can be hinged on the left or the right side.



Tool case

Depth	Width	Height	Kg	Part.No
297	354	82	1,6	6302

The case comes with a mix of inserts. Additional inserts can be purchased separately.

Case inserts

Depth	Width	Height	Part.No
40	77	68	6317
81	77	68	6318
163	77	68	6319

Will also fit pegboard tray 4360 and 4362, page 22.



Tool case compartment

Depth	Width	Height	⇒	Kg	Part.No
300	392	110	100%	2,5	6300

With the tool case compartment you can fit a case in a stack of drawers.

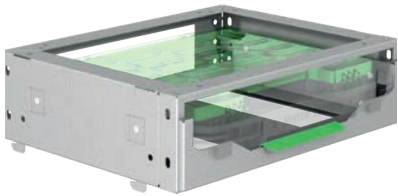

Tool case bracket

Depth	Kg	Part.No
300	0,5	6305
470	0,7	6306

The Edström portable tool case can be mounted directly on the frame with 2 brackets.

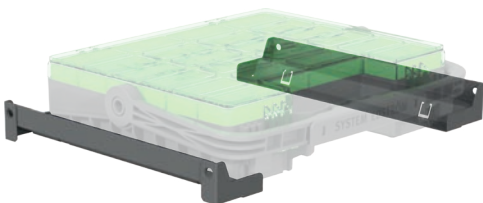

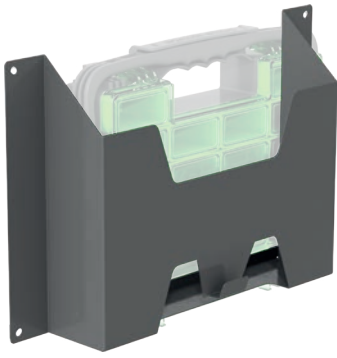

Tool case holder

Depth	Width	Height	Kg	Part.No
86	565	295	1,4	6307

This bracket is mainly designed to fit on to our shelf frames, you can rotate the holder to fit on racking with both 300 and 470 mm depths.

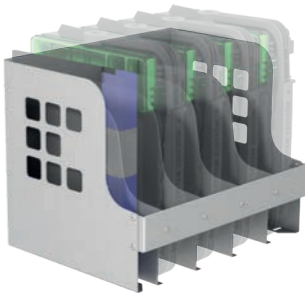

Tool case/File holder

Depth	Width	Height	Kg	Part.No
304	383	299	4,4	6308

Up to four cases and a binder can be stored in the holder. Should be placed in a shelf.

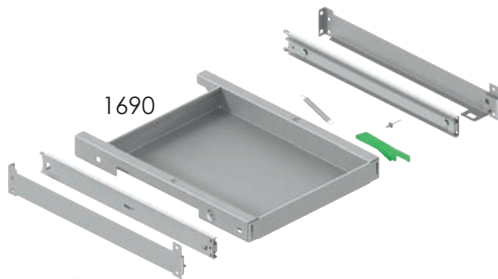

Tool case storage

Depth	Information	Kg	Part.No
300	Top shelf 446 mm	1,9	1686
470	Tool case shelf 392 mm	4,3	1690
300	Rail (Systainer)	0,4	2305
470	Rail (Essve)	1,6	2310

Top shelf, 1686, is to be used with rail 2305 for simple storage of Systainer type tool cases.

Tool case shelf, 1690, will fit in a rack 470 mm deep and 392 mm wide. Similar tool cases will also fit, w x d 396 x 296 mm.

NOTE! We dont have this type of tool cases in our range.

Rail 2310 is designed for Essve tool cases and fits in a rack 470 mm deep and 605 mm wide.

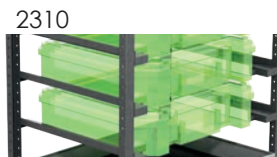



We k
mob



**know how to create
safe workplaces.**



Vice

Depth	Width	Height	Kg	Part.No
360	135	140	10,3	5004

The forged vice is complete with pipe jaw and turning plate. Max opening 140 mm.



Vice Holders

Depth	Width	Height	⇒	Kg	Part.No
1110	210	195	600 mm	9,4	5012
1110	210	80	600 mm	8,9	5013

Plate measurement 180x210 mm. Cover 2950 is included (see below).



Extendable Vice Holder/Bench

Width	Height	⇒	Goes with	Kg	Part.No
1200	151	750 mm	997 mm	12,4	2720
1400	151	900 mm	1176 mm	14,3	2721

Fits both 300 and 470 mm deep shelf frames, can be turned for mounting on both right and left sides.

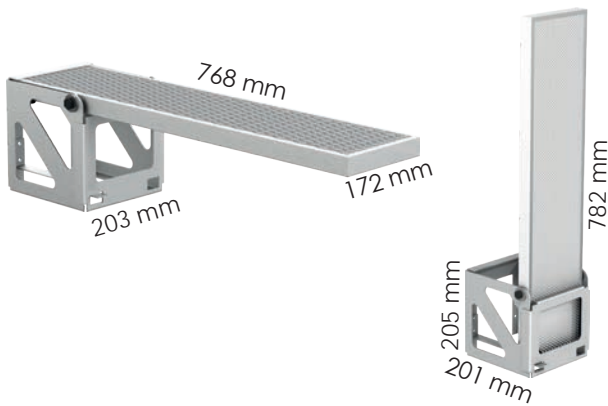

Foldable Vice Holder/Bench

Kg	Part.No
6,0	2724



Accessories to Vice Holders

Description	Kg	Part.No
Cover, included in 5012 & 5013	1,1	2950
Adjustable support, 520 - 800 mm	1,9	2952

Adjustable support (2952) fits 2724, 5012 and 5013.

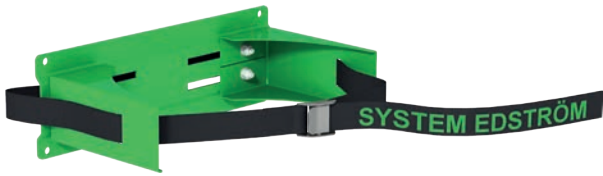

Gas bottle holder adjustable

Depth	Width	Height	Tube Ø	Kg	Part.No
150	300	97	< 300	0,9	2910

Liquefied petroleum gas P6 (bottles with 320 mm Ø can be stored after modification).



Gas bottle holder single

Depth	Width	Height	Tube Ø	Kg	Part.No
70	300	200	< 300	0,8	2912

Liquefied petroleum gas P6, could also be used for storing refrigerant bottles.



Gas bottle holder double

Depth	Width	Height	Tube Ø	Kg	Part.No
95	300	200	145	1,3	2913

5 kg Acetylene & Oxygen tubes.



Gas bottle holder shelf

Depth	Width	Height	Kg	Part.No
300	306	500	6,3	2914

Liquefied petroleum gas P11 or 5 kg Acetylene & Oxygen. Bracket for two bottles is included.



Gas bottle holder wallmounted

Depth	Width	Height	Tub Ø	Kg	Part.No
300	450	820	205	5,8	2916

Acetylene & Oxygen (AGA A21 & O20 or equivalent).



Case support

Depth	Length	Height	Kg	Part.No
220	1568	195	2,0	2935
-	-	-	0,6	2936

Adjustable bracket ideal for fixing between shelf frames to secure tool cases, for example. Comes in 1568 mm length, can be cut to fit your configuration. Add an extra bracket (2936) for maximum flexibility, one is included.



Hose/Cable rack

Depth	Width	Height	Kg	Part.No
79	267	168	0,5	4077
135	110	85	0,3	4080

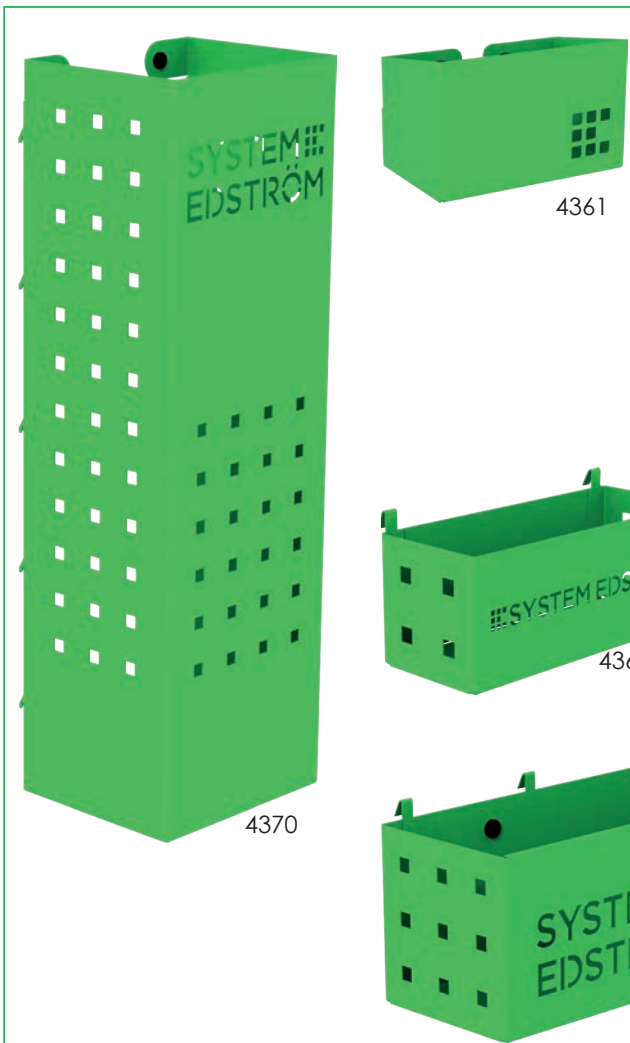

Pegboard tray

Depth	Width	Height	Kg	Part.No
82	200	80	0,5	4360
62	100	64	0,1	4361
82	285	102	0,8	4362
122	455	122	1,5	4364
153	179	575	3,0	4370

A number of different trays that solve (almost) all storage problems. Our tool case inserts, page 16, fit in 4360 and 4362, ideal for your small items that lack storage space.



4368



4359

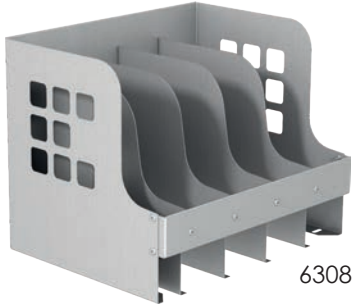

6308

File holders

Depth	Width	Height	Kg	Part.No
21/31	65	79	0,1	4359
34/69	231	210	0,6	4368
304	383	299	4,4	6308

Not everything is digital. These provide storage for binders, brochures, etc. In 6308, you can store a mix of our tool case, page 16, and binders. These should be placed on a shelf. 4359 is suitable for your business cards.



Grab handle

Depth	Width	Height	Ø	Part.No
77	30	275	27	4390

The handled is mounted on a shelf frame or directly in your vehicle's chassis.



Work bench

Depth	Width	Thickness	Kg	Part.No
500	900	30	9,2	6035
500	1300	30	13,4	6036
500	1700	30	16,5	6037
500	2100	30	20,5	6038
500	3000	30	30,5	6039





Universal hook mini

Depth	Width	Height	Part.No
50	50	88	4355

Sold in a set of 2 pieces.



Universal hook

Depth	Width	Height	Part.No
85	80	100	4356

Sold separately.

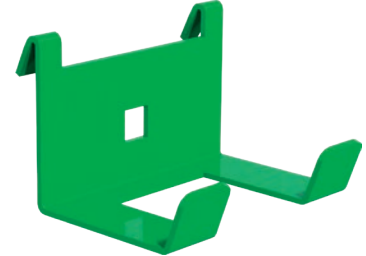

Universal hook double

Depth	Width	Height	Part.No
61	83	55	4357

Sold separately.

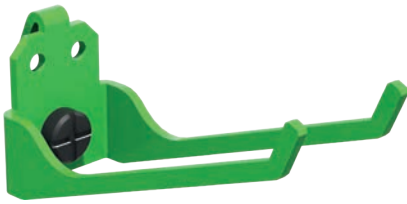

Angled hook

Depth	Width	Height	Part.No
111	40	48	4340

Sold separately.



Clothes hook 300

Depth	Width	Height	Part.No
31	295	40	2706

Sold separately.



Clothes hook 470

Depth	Width	Height	Part.No
31	465	40	2708

Sold separately.

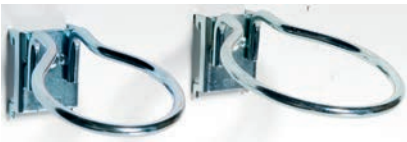

Ring hook

Ø	Part.No
60	4314
80	4315

Sold in a set of 5 pieces.



Rubber clip

Ø	Part.No
25	4325
38	4326

Sold in a set of 5 pieces.



Document clip

Width	Part.No
60	4330

Sold in a set of 5 pieces.



Power tool holder

Depth	Width	Height	Part.No
72	80	140	4380

Sold separately.



Battery holder

Depth	Width	Height	Part.No
63	91	103	4381

Sold separately.



Tool holder

Depth	Width	Height	Part.No
81	285	150	4375

Sold separately.



Tube holder

Depth	Width	Height	Part.No
90	286	150	4348

Sold separately.



Tube holder

Depth	Width	Height	Part.No
66	194	123	4349

Sold separately.



Spray can holder

Depth	Width	Height	Part.No
72	75	125	4351

Sold separately.



Can holder mini

Depth	Width	Height	Part.No
65	75	88	4352

Sold separately.



Can holder, plastic

Depth	Width	Height	Part.No
77	76	190	4358

Sold separately.

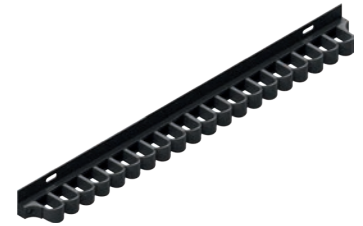

Clamping rack

Depth	Width	Height	Part.No
91	103	63	4354

Sold separately.

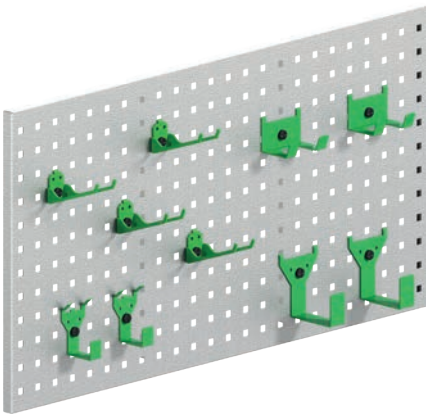

Tool holder kit

Parts	Part.No
9 + expander locks	F11004



Expander lock for pegboards

Part.No
5680

Sold separately.

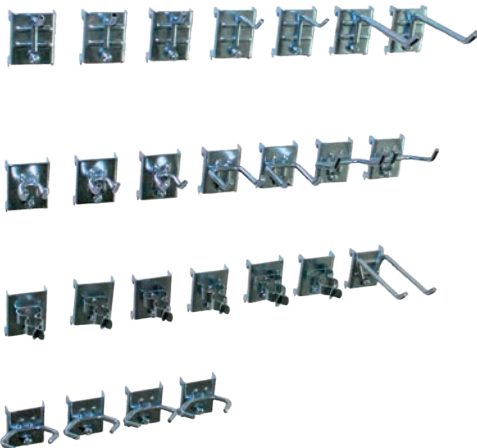

Tool holder kit

Parts	Part.No
25	4319

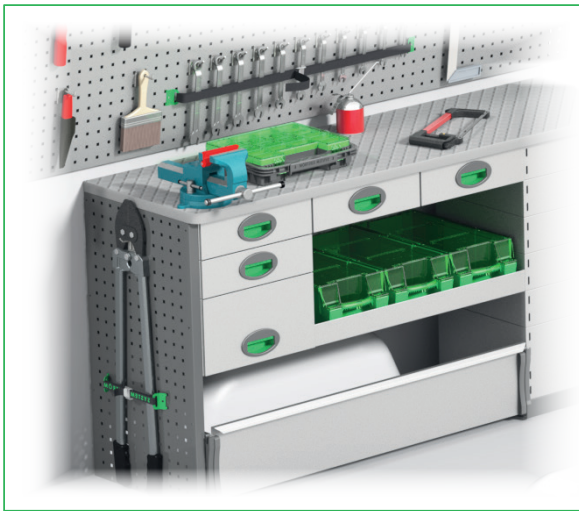

Strap with brackets

Information	Width	Part.No
1200 mm, nylon strap	25	4365
1000 mm, elastic strap	25	4366

Brackets fit on our pegboards.

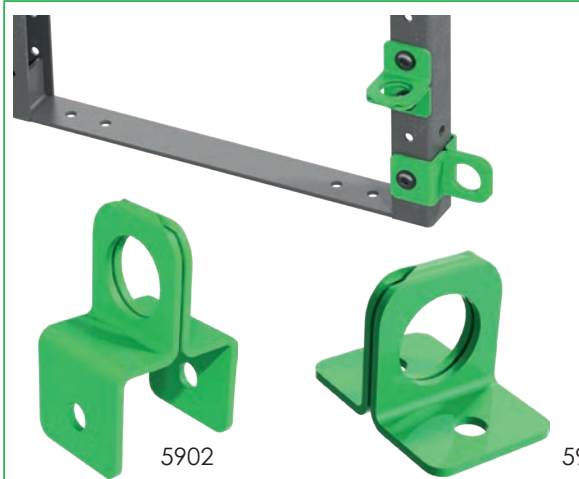

Lashing ring

Depth	Width	Height	Ø	Part.No
36	58	30	20	5902
46	32	30	20	5903

Mounts on a shelf frame, designed to hold lighter loads in place. Sold in a set of 2 pieces.

Nylon strap

Length	Width	Part.No
4000	30	5107

2-part with tensioner.

Nylon strap

Length	Width	Part.No
2520	25	5117

2-part with hooks.

Nylon strap

Length	Width	Part.No
2500	25	5118

Lashing ring

Part.No
5098
5099

Rubber strap

Length	Part.No
-	5121
285	5122
By the metre Whole package 10 metre.	5124
285	5125

Paper dispenser



Information	Part.No
Dispenser DxWxH 205x319x141 mm	4070
Wet wipe dispenser holder	4387
Magnetic bracket to 5084	5083
Dispenser with paper	5084
Paper to 5084	5086

The magnetic brackets allows you to bring the holder with you.

Fire extinguisher



Information	Part.No
2 kg, powder	5055
4 kg, powder	5056
6 kg, powder	5057

Wall bracket is included.

First aid



Information	Part.No
First aid board	5080
First aid kit	5082

Foldable holder for garbage bag



Depth	Width	Height	Part.No
300	278	87	4385

Water can



Information	Part.No
Bracket	2970
Water can with tap, 5 litres	2972

The bracket can be mounted on a shelf frame or pegboard. Bracket and can sold separately.

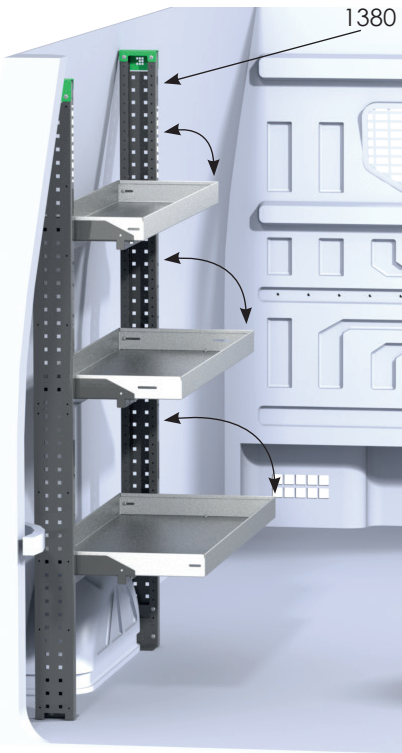

Flexi shelf frame

Depth	Width	Height	Info.	Kg	Part.No
112	32	1788	2/set	11,8	1380
112	31	1788	1/set	4,9	1382

Flexi shelf support

Depth	Width	Height	Shelf width	Kg	Part.No
275	830	83	784	3,1	1308
275	1043	83	997	3,5	1312
275	1222	83	1176	3,9	1316
275	1435	83	1389	4,4	1322
275	1614	83	1568	4,8	1326

Flexi shelf bracket

Info.	Kg	Part.No
160 mm deep shelves, 2/set	0,6	1340
300, 400 & 470 mm deep shelves, 2/set	1,4	1342

Flexi gas damper

Info.	Kg	Part.No
2/set	0,1	1386

The shelf frames can be cut to fit your configuration. Loading capacity increases to 100 kg per shelf when mounted in a Flexirack. Shelves are adjustable to 4 pre-set angle on installation of 0, 4, 8 & 12 degrees.

Choose your shelves , 300, 400 and/or 470 mm depth. Our dropfront shelves will also fit, 300 and 470 mm depth. A shelf bracket will fit all different shelf depths.

Use the shelf bracket if you want to combine 160 mm deep shelves with other depths. 160 mm shelves are fixed, not foldable.

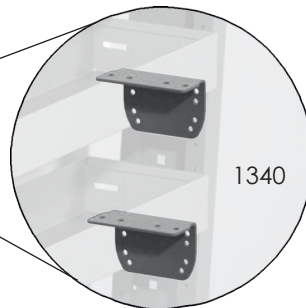

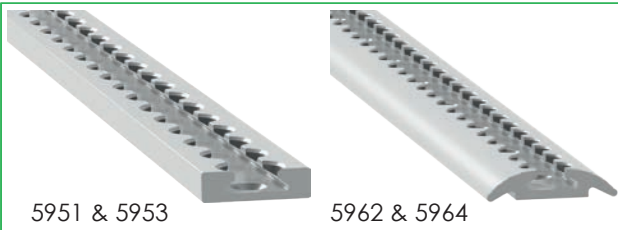

5951 & 5953

5962 & 5964

Airline tracks

Length	Kg	Part.No
295	0,2	5951
465	0,3	5953
1000	0,8	5962
1500	1,2	5964



2813

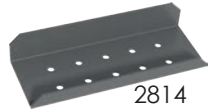

2814



5904



5905



5900

5901

Airline lashing rings

Information	Kg	Part.No
Round aluminium	0,1	5900
Straight black plastic	0,1	5901



5910



5911

Airline brackets

Information	Kg	Part.No
Angle bracket 53x80x112 mm	0,2	2813
Support plinth bracket 175x66x15/32 mm	0,3	2814
Bracket for shelf frame	-	5904
Bracket for plywood	-	5905
T-nut 2xM6	-	5910
T-nut 3xM6	-	5911
Mounting bolt M8x25	-	5913
Clamp fitting	0,3	5915



5913



5915



5931 - 5935



5940

Airline straps

Information	Length	Kg	Part.No
Strap	200/ 700	0,1	5931
Strap	200/1200	0,1	5933
Strap	200/2200	0,2	5935
Strap with tensioner	500/2500	0,3	5940
Adjustable beam	1100-1550	2,6	5993
Adjustable beam	1500-2200	3,5	5996



5993 & 5996

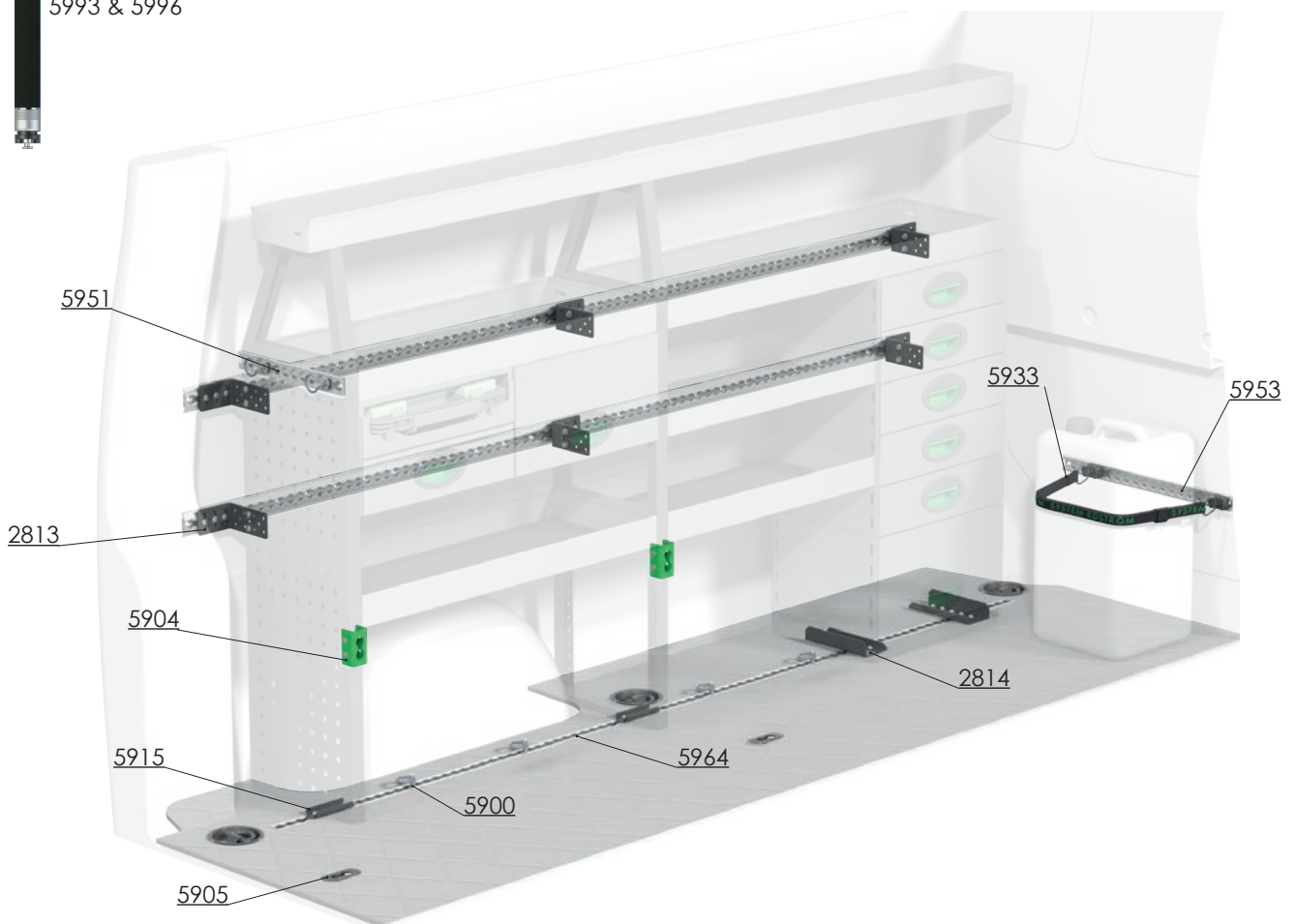

CarLock



Information

2 locks
3 locks

Part.No

5490
5491

An extra locking system for your cargo space to avoid unwelcome surprises. Can help discourage thieves completely. The system is mounted inside the van without being visible. Decals that show you have an extra lock mounted are included. The system consists of 2 to 3 corrosion-free pistol locks (one for each door), with a 17 mm stainless steel locking piston. You choose whether you want to lock with a remote-control key or have automatic locking when you leave the car. Class 3 approved by the Swedish Anti-Theft Association.

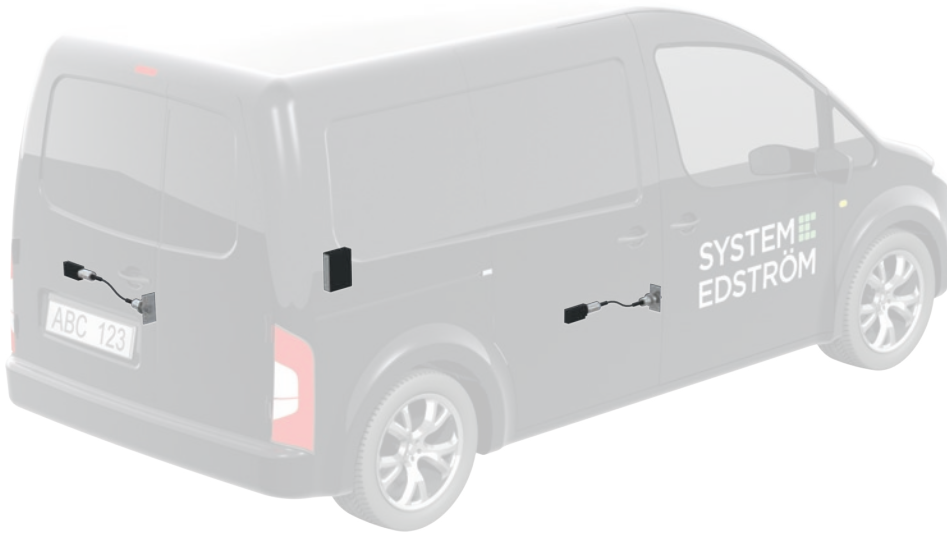

Pipe tube



Length	Width	Height	Kg	Part.No
3030	122	123	13,9	8469

Our proven pipe carrier is openable in both ends with lockable end caps.

Internal ladder holder



Length	Kg	Part.No
2400	5,5	T8900

Our internal ladder holder allows you to store your ladder on the inside of the roof and pull it back to the rear door simply. The aluminium rail comes in two parts with a joining piece.



LED lighting



Description	Length	Watt	Part.No
12/24V, 30 diodes	500	7,2	5815
Lighting kit with 2 tubes		14,4	F8320
Lighting kit with 3 tubes		21,6	F8321
Lighting kit with 4 tubes		28,8	F8322
Lighting kit with 5 tubes		36,0	F8323
Lighting kit with 6 tubes		43,2	F8324

The set consists of tube 5067, cable, fuse and two rocker switches.

Pure sine wave inverter



Depth	Width	Height	Watt	Kg	Part.No
210	106	60	400	0,8	5430
320	170	80	1200	3,8	5431
450	166	88	2000	4,9	5432

Protected:

- Short circuit
- High temperature
- Overvoltage
- Undervoltage
- Overload
- Incorrect input polarity

We have worked with trusted supplier Awimex to design an inverter series that ensures a trouble-free power supply.



Angle brackets

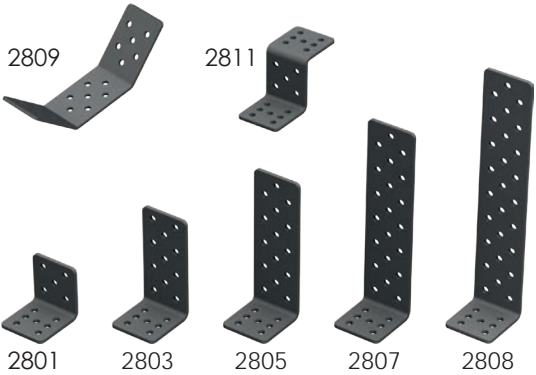

Width	Measurement	Part.No
53	58 x 58	2801
53	58 x 112	2803
53	58 x 154	2805
53	58 x 209	2807
53	58 x 264	2808
53	80:87:80	2809
53	58:64:58	2811

Mounting brackets



Length	Measurement	Kg	Part.No
200	26 x 54	0,3	2081
295	50 x 30	0,3	2810
460	50 x 30	0,5	2812
2000 (5 pcs)	50 x 30	12,3	2816
1568	50 x 30	2,0	2817
1200		0,9	7388

2081 is designed for use with our shelf frames. For example, you can join two frames on top of each other.
7388 is a pole with the same profile as our shelf frames.

L-type support rail

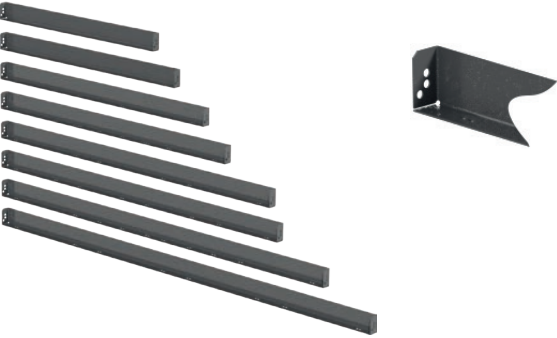

Length	Measurement	Kg	Part.No
694	55 x 30	0,7	2819
784	55 x 30	0,8	2820
907	55 x 30	0,9	2822
997	55 x 30	1,0	2824
1176	55 x 30	1,2	2826
1210	55 x 30	1,2	2827
1389	55 x 30	1,4	2828
1568	55 x 30	1,6	2829

Brackets



Depth	Height	Kg	Part.No
160		0,3	1840
300		0,5	1842
	260-410 mm	0,9	1844
	235-410 mm	0,6	2830

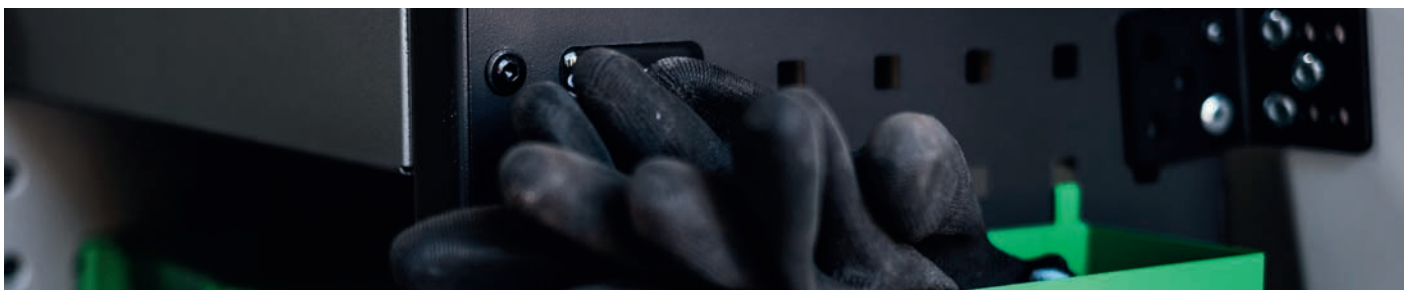

Installation kits



Information	Parts	Part.No
Mixed parts, size 1	146	5501
Mixed parts, size 2	238	5502
For Flexi system		5509
For vice and vice holder	57	5510
False floor installation kit	93	T5310

Flipfront

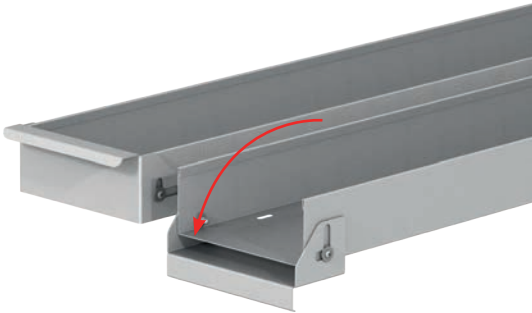

Depth	Kg	Part.No
160	0,3	1831
300	0,5	1833

Shelf joint

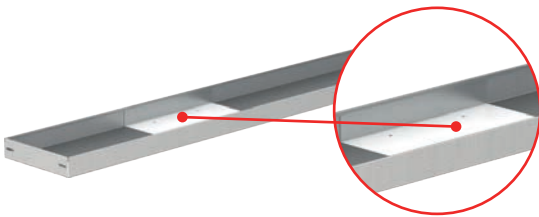

Depth	Width	Height	Kg	Part.No
300	400	62	1,3	1834

If you need a shelf width not included in our standard range, use the shelf joint to shorten a shelf or connect two shelves to you desired width. (Only with 300 mm deep shelves.)

Cross brace



Kg	Part.No
0,8	2850

The brace is suitable for all sizes of sliding shelves and shelf frames above 505mm. It can also be used in conjunction with our standard shelves up to 1176mm in length.



Threaded insert nut

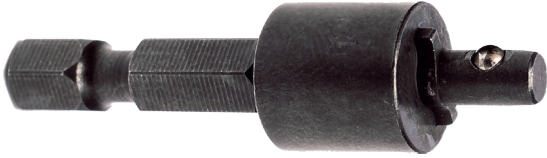

Information	Pack	Part.No
Insert nut M6x9 mm	1000	7180
Insert nut M6x12 mm	1000	7181
Tool for insert nut		7182

Nuts & Bolts



M6

M8



5600



5620



5640



5642



7172

Ø	Length	Pack	Part.No
M6	10	1000	5600
M6	12	1000	5611
M6	16	500	5612
M6	20	500	5614
M6	25	500	5616
M6	35	500	5620
M6	50	100	5624
M6	Nut	1000	5640
M6	Washer Ø 22	200	5642
M6	Tee nut	1000	7172
M8	16		7113
M8	20		7114
M8	30		7115
M8	35		7116
M8	40		7117
M8	50		7118
M8	60		7119
M8	Nut		7122
M8	Washer Ø 28		7123
M8	Tee nut		7173

Blind Rivet



5662



5672

Ø	Length	Pack	Part.No
4,8	10	Steel	5670
4,8	10	Alu	5672
4,8	14	Steel	5650
4,8	21	Steel	5652
4,8	30	Steel	5654
6,4	15	Steel	5660
6,4	18	Steel	5661
6,4	22	Steel	5662
6,4	30	Steel	5664
6,4	35	Steel	5665
6,4	40	Alu/Steel	5666

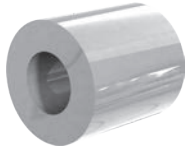

Distance tube for pegboards

Part.No
3031



Edström colours

Information

Dark grey, spray can
Light grey, spray can
Edström green, spray can

Part.No
9007
9014
9015



Index

Accessories to Vice Holders	22	Internal ladder holder	32
Adjustable shelves with flipfront	9	Lashing ring	28
Airline lashing system	31	Lashing ring rail	16
Angle brackets	34	LED lighting	33
Angled hook	26	Load carrier	17
Ball bearing kit for shelves	9	Locking bars	12
Battery holder	26	L-type support rail	34
Blind Rivet	36	Mounting brackets	34
Bracket for dropfront shelves	11	Nuts & Bolts	36
Brackets	34	Nylon straps	28
Cabinets	17	Paper dispenser	29
Can holder mini	27	Pegboards	14
Can holder, plastic	27	Pegboard tray	24
Carlock	32	Pipe tube	32
Case inserts	18	Plastic bin for shelves	11
Case support	24	Power tool holder	26
Clamping rack	27	Pure sine wave inverter	33
Clothes hook 300	26	Ring hook	26
Clothes hook 470	26	Rubber clip	26
Cover plate sliding drawers	7	Rubber mats	13
Cross brace	35	Rubber mats to sliding drawers	12
Distance tube for pegboards	37	Rubber strap	28
Dividers for dropfront Shelves	10	Shelf dividers	8
Dividers for plastic bins	11	Shelf for cable reels	9
Dividers for sliding drawers	7	Shelf frames	4
Document clip	26	Shelf joint	35
Drawer foam inserts	6	Shelves	8
Drawer inserts	6	Sliding drawers	7
Drawers	5	Sliding drawer & shelf frame	15
Drop fronts	10	Sliding pegboard	15
Dropfront shelves	10	Sliding platform chassis	16
Edström colours	37	Spray can holder	27
Expander lock for pegboards	27	Strap with brackets	28
Extendable Vice Holder/Bench	22	Support plinths	6
File box	17	Threaded insert nut	36
File holders	25	Tool case	18
Fire extinguisher	29	Tool case storage	19
First aid	29	Tool compartments	17
Flexi System	30	Tool holder	26
Flipfront	35	Tool holder kit	27
Foldable holder for garbage bag	29	Top plates	6
Foldable Vice Holder/Bench	22	Transparant lid for plastic bins	11
Frame	16	Tube holder	27
Gas bottle cabinet	17	Universal hook	26
Gas bottle holders	23	Vice	22
Grab handle	25	Vice Holders	22
Hose/Cable rack	24	Water can	29
Installation kits	35	Work bench	25

INFORMATION



GENERAL INFO

All kits include what you see in the drawing, as well as installation parts, rubber mats for all shelves and foam for drawers.

System Edström Bilinredningar AB is certified SS-EN ISO 9001:2015, ensuring our commitment to managerial quality and high accuracy in our deliveries.

All materials used by System Edström are 100% recyclable. We are also certified to SS-EN ISO 14001:2015.



REMEMBER

By choosing System Edström for your vehicle, you have taken the first and most important step to making your mobile workshop safe and functional. From here on, it is up to you how safe and functional your working place will be.

As the driver, you have full responsibility if you or anyone else is injured owing to poorly secured cargo. You are also responsible for ensuring the interior is mounted in the safest way possible, whatever your choice of workshop, even when using professional, knowledgeable and experienced installers.

DO NOT exceed the maximum payload of the vehicle.



SECURITY

Our products are safety tested with crash testing to the most stringent standards. All our products are crash tested to ECE 17:07 by Millbrook in England, and also Valutec in France (INRS NS286).

Find out more about our company and products at www.systemedstrom.com.





Scan this code for price information.



Up to 5 years warranty



Crash tested



Made in Sweden

SYSTEM EDSTRÖM

SYSTEM EDSTRÖM BILINREDNINGAR AB
Råseborgsgatan 11
164 74 Kista
Sweden

Order +46 (0)10 102 95 00
Sales +46 (0)10 102 95 01
Switchboard +46 (0)8 590 920 20
E-mail info@edstrom.se